



SunTech® **247**™
BP + VITALS

User Guide

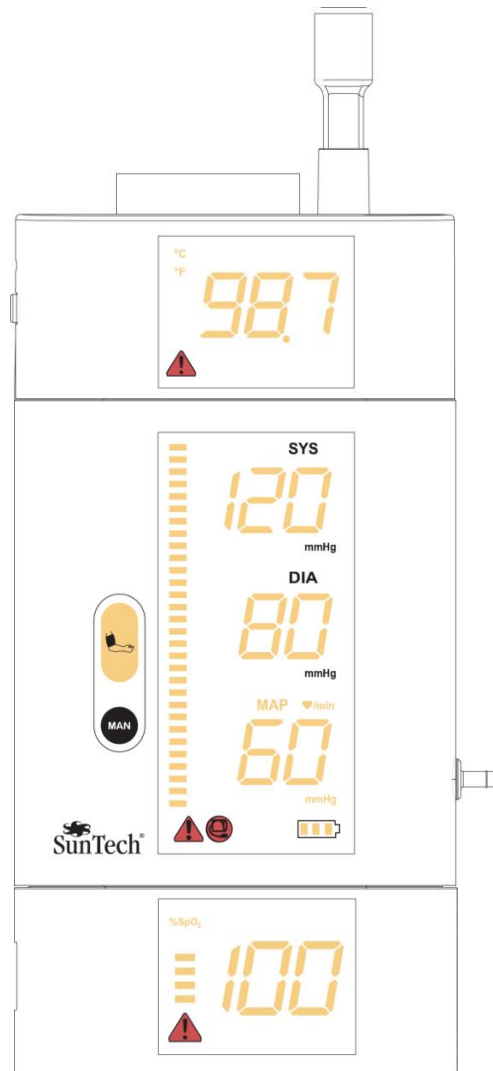

SunTech® 247™

Blood Pressure Device for Automated and Manual Measurement



About this Manual

This manual describes features and uses of the SunTech 247™ by SunTech Medical®, Inc., a non-invasive, clinical-grade automated device to measure blood pressure, pulse rate and mean arterial pressure. Optional modules to measure temperature and functional oxygen saturation are available, and their use is also described in this manual.

- This manual accompanies all the versions of the *SunTech 247*:

<i>SunTech 247</i> Versions*	
Item Name	Item Description
<i>SunTech 247</i> BP	BP device
<i>SunTech 247</i> : BP & Temperature	BP device with temperature
<i>SunTech 247</i> : BP & SpO ₂	BP device with SpO ₂
<i>SunTech 247</i> : BP, Temperature & SpO ₂	BP device with SpO ₂ and temperature
<i>SunTech 247</i> Battery: BP	BP device with rechargeable battery
<i>SunTech 247</i> Battery: BP & Temperature	BP device with temperature and rechargeable battery
<i>SunTech 247</i> Battery: BP & SpO ₂	BP device with SpO ₂ and rechargeable battery
<i>SunTech 247</i> Battery: BP, Temperature & SpO ₂	BP device with SpO ₂ , temperature, and rechargeable battery

* All above versions are available with a *Bluetooth*® wireless communication option.

This document is designed to help you quickly familiarize yourself with your *SunTech 247*, and subsequently, to use it to its full potential. Dispersed throughout the body of the manual are tips, notes and warnings to enable you to use your *SunTech 247* easily, safely and effectively.

Changes and Reissues

This manual is identified as Part Number: 80-0040-00. Changes occurring between issues of this document are addressed through change information sheets, addenda, or replacement pages. If none of these accompany this manual, the manual is correct as printed.

Should you notice errors or omissions in this manual, please notify us at:

SunTech Medical

507 Airport Boulevard, # 117

Morrisville, North Carolina 27560-8200

USA

Phone: 919.654.2300 Fax: 919.654.2301 E-mail: CustomerService@SunTechMed.com

Copyright Information

All content in this manual is the proprietary information of *SunTech Medical* and is provided solely for purposes of operation, maintenance or service of the *SunTech 247*. This manual and the *SunTech 247* described in it are protected under copyright law under which they may not be copied, in whole or in part, without written consent of *SunTech Medical*.

SunTech is a registered trademark of *SunTech Medical, Inc.* All other trademark names are the trademarks of their respective holders.

The information in this manual is furnished for guidance only, is subject to change without notice, and should not be construed as a commitment by *SunTech Medical*. *SunTech Medical* assumes no liability for errors or inaccuracies that may appear in this manual.

© 2007 *SunTech Medical*. All rights reserved.

KEYS AND ACRONYMS

Acronyms

Acronyms commonly used in this document include:

APC	A <i>SunTech</i> proprietary acronym for “All Purpose Cuff”
BP	Blood pressure
HR	Pulse rate
K-sound	Korotkoff sound
MAP	Mean arterial pressure
NIBP	Non-invasive blood pressure
EMR/EHR	Electronic Medical Records/Electronic Health Records

Document Key

This manual uses the following icons to call attention to specific instructions or guidance.



TIP: A step or process that eases or enhances your use of your *SunTech 247* device.



NOTE: Indicates something you *must* do to use your device correctly and effectively.



CAUTION: Warns you that not following these instructions can cause injury, harm or serious damage.

Indications for Use

The *SunTech 247* NIBP , Temperature, and Pulse Oximeter device is indicated for use in measuring and displaying Systolic and Diastolic blood pressures, pulse rate, temperature, and functional oxygen saturation (SpO₂) of adult and pediatric patients in hospitals, medical facilities, clinics, physicians offices, and other sub-acute environments.

User Responsibility



Your *SunTech 247* product is designed to perform in conformity with the description contained in this operation manual and accompanying labels and inserts, when assembled, operated, maintained and repaired in accordance with the instructions provided. It is your responsibility to:







- Check calibration of the device every two years.
- Never knowingly use a defective device.
- Immediately replace parts that are broken, worn, missing, incomplete, damaged or contaminated.
- Contact the nearest factory approved service center should repair or replacement become necessary. A list of approved service centers appears on page 46 or on our website at www.SunTechMed.com.

Further, the user of the device bears sole responsibility for any malfunction that results from improper use, faulty maintenance, improper repair, damage or alteration by anyone other than *SunTech Medical* or authorized service personnel.

Warnings and Contraindications

Please read this manual thoroughly before starting to use your *SunTech 247*. Only those clinicians trained to measure, record and interpret vital signs should use this device.

	Do not use this device on pediatric patients under 3 years old, infants, or neonates.
	The <i>SunTech 247</i> must be charged before using it for the first time.

	<p>For accurate blood pressure measurements, ensure that the circumference of the arm fits within the range markings on the cuff.</p>
	<p>The <i>SunTech 247</i> is not intended for continuous monitoring. Although the blood pressure cuff and cable are defibrillator proof, the temperature probe and SpO₂ sensor are not. Do not leave the device unattended while taking measurements on a patient.</p>
	<p>Only use such accessories as are recommended for use with this device. A list of recommended accessories is on page 61.</p>
	<p>Do not operate the <i>SunTech 247</i> near flammable anesthetics or volatile vapors. An explosion may result.</p>
	<p>Compressing the pneumatic tubing may cause system errors.</p>
	<p>Do not use the device if it has failed its diagnostic self test or if it displays a greater than zero pressure with no cuff attached or a value of functional oxygen saturation or temperature with no sensor attached.</p>
	<p>Prevent water or other fluids from entering any connectors or vents on the device. Should this happen, all connectors should be dried with warm air. Then check the calibration of the device and operating functions before reusing.</p>







	<p>Do not make repairs yourself. Equipment must be returned to <i>SunTech</i> or authorized service personnel for repairs. Substitution of a component different from that supplied may result in measurement error.</p>
	<p>If the <i>SunTech 247</i> is dropped or mishandled, please have it checked by a authorized service center before bringing it back into use.</p>
	<p>The <i>SunTech 247</i> is not intended for patients connected to a cardiopulmonary bypass machine.</p>
	<p>At least every three months, inspect probes, cords and accessories for fraying or other mechanical damage. Replace as necessary.</p>
	<p>Check the calibration of your <i>SunTech 247</i> at least once every two years.</p>
	<p>If Luer Lock connectors are used in the constructions of tubing, there is a possibility that they might be inadvertently connected to intravascular fluid systems, allowing air to be pumped into a blood vessel.</p>

TABLE OF CONTENTS

Changes and Reissues	iii
Copyright Information	iii
KEYS AND ACRONYMS.....	IV
Acronyms.....	iv
Document Key.....	iv
Indications for Use	v
User Responsibility.....	v
Warnings and Contraindications	v
TABLE OF CONTENTS	VIII
GETTING TO KNOW THE <i>SUNTECH 247</i>	1
Package Contents.....	1
The <i>SunTech 247</i> Kit	1
The <i>SunTech 247</i> Battery Kit.....	2
Accessory Modules	2
Other Accessories.....	2
A Bird's Eye View.....	3
BP module	3
BP display.....	5
Optional temperature and pulse oximetry modules	6
Optional temperature and pulse oximetry displays.....	8
Icons and Cues	9
Auditory Cues	9
Visual Cues – Battery Icon.....	10
Visual Cues – Blood Pressure Module	10
Visual Cues – Temperature Module.....	11
Visual Cues – Pulse Oximetry Module	12
QUICK START GUIDE	14
Measuring Blood Pressure and Pulse Rate Automatically	14
Measuring Blood Pressure Using Sphygmode.....	14
Measuring Temperature.....	15
Measuring Oxygen Saturation	15
SETTING UP THE <i>SUNTECH 247</i>.....	16

Safety Precautions.....	16
Protecting Your Patient.....	16
Protecting Yourself.....	16
Protecting Your <i>SunTech 247</i>	16
Mounting Your Device	17
Mounting the Device on a Wall.....	17
Affixing the Device to a Mobile Stand.....	17
Placing the Device on a Tabletop	17
First-Time Setup	18
Connecting Your Device	18
Charging the Battery.....	18
Selecting Temperature Unit of Measurement	19
Powering Up.....	19
MEASURING BLOOD PRESSURE WITH THE <i>SUNTECH 247</i>	20
Prepping Your Patient	20
Selecting the Right Cuff	21
Taking a Measurement	22
Taking an Automated Measurement.....	22
Taking a Sphygmode Measurement.....	23
K-Sounds: A Primer.....	24
MEASURING TEMPERATURE WITH THE <i>SUNTECH 247</i>.....	25
Temperature Units of Measurement	25
Temperature Measurement Modes	25
Using temperature probe and probe covers	25
Taking an Oral Temperature	26
Taking an Axillary Temperature.....	27
Taking a Rectal Temperature.....	27
MEASURING OXYGEN SATURATION WITH THE <i>SUNTECH 247</i>	29
Prepping the Patient.....	29
Selecting the Right Sensor	29
Protecting Your Pulse Oximetry Sensors.....	29
Guidelines for Use	30

Measuring Oxygen Saturation with Sensor on Finger	30
Measuring Oxygen Saturation with a Earlobe Sensor.....	31
MANAGING READINGS	32
Recalling the Last Set of Readings	32
Clearing the Last Set of Readings.....	32
MAINTAINING THE <i>SUNTECH 247</i>.....	33
Routine Maintenance	33
Cleaning.....	33
Checking the Calibration of Your Device	34
Replacing the Rechargeable Battery	35
Attaching the Temperature Module.....	36
Attaching the Pulse Oximetry Module	38
Storage, Shutdown, Transport	39
Storage	39
Moving Your Device.....	39
TROUBLESHOOTING	40
Troubleshooting – Blood Pressure Module	40
Troubleshooting – Temperature Module	41
Troubleshooting – Pulse Oximetry Module.....	42
FAQs.....	44
Web Resources	46
Service Centers	46
For customers in the Americas.....	46
For customers in Europe, the Middle East, and Africa	47
For customers in Asia and the Pacific.....	47
SPECIAL SITUATIONS	48
Special Situations.....	48
Measuring Blood Pressure in Children	48
Measuring Blood Pressure in Obese Patients	48
Measuring Blood Pressure in the Presence of Arrhythmia.....	48
Measuring Blood Pressure During Pregnancy.....	48
Measuring Blood Pressure in the Elderly.....	49
Measuring Blood Pressure in the Emergency Room.....	49
Measuring Blood Pressure in the Presence of Orthostatic Hypotension.....	49

APPENDICES.....	50
Specifications	50
Compliance.....	51
Safety Requirements.....	51
EMC Statement.....	52
Symbols.....	52
EU and FCC Regulatory Information	58
Limited Warranty.....	59
Purchasing Parts and Accessories	61

GETTING TO KNOW THE *SUNTECH 247*

Your *SunTech 247* is a model of functionality, offering consistent blood pressure measurements along with reliable temperature and functional oxygen saturation readings.

Package Contents

The *SunTech 247* is available in two versions – with and without a rechargeable battery. Contents for each version are listed below.



Upon opening your kit, please ensure that all listed contents are included. If any contents are missing or damaged, please contact *SunTech*.

The *SunTech 247* Kit

The *SunTech 247* kit contains your AC powered device. Your kit will also contain:

- An 8-foot blood pressure hose
- Adult and large adult size all purpose cuffs
- A wall mounting kit
- A power supply
- A geography specific power cord
- A CD with this manual
- A quick start guide
- A warranty card



Please mail your completed warranty card.



The *SunTech 247* must be plugged in and charged before first use.

The *SunTech 247* Battery Kit

The *SunTech 247* Battery kit consists of a rechargeable battery powered device. The remainder of its contents matches the *SunTech 247* kit.

Accessory Modules

Accessory modules that you can purchase from your distributor or *SunTech* to enhance usability of your *SunTech 247* include:

- A temperature module that includes the oral/axillary probe and one box of disposable probe covers. A rectal probe option is available separately.
- A Nellcor®-compatible pulse oximetry module with an adult reusable finger sensor (3ft/0.9m length) and sensor extension cable (6ft/1.82m length).
- A vSat pulse oximetry module with an adult reusable finger sensor (10ft/3m length).

Other Accessories

Many other accessories and sources for purchasing them are listed in the Appendix on page 61. A few to note include:

- An APC Adult package (contains one each of the following cuff sizes: Small Adult, Adult, Adult Long and Large Adult)
- An APC Pediatric cuff package (contains one each of the following cuff sizes: Child, Small Adult)
- A rectal temperature kit compatible with the temperature module
- Other reusable pulse oximetry sensors

A Bird's Eye View

BP module

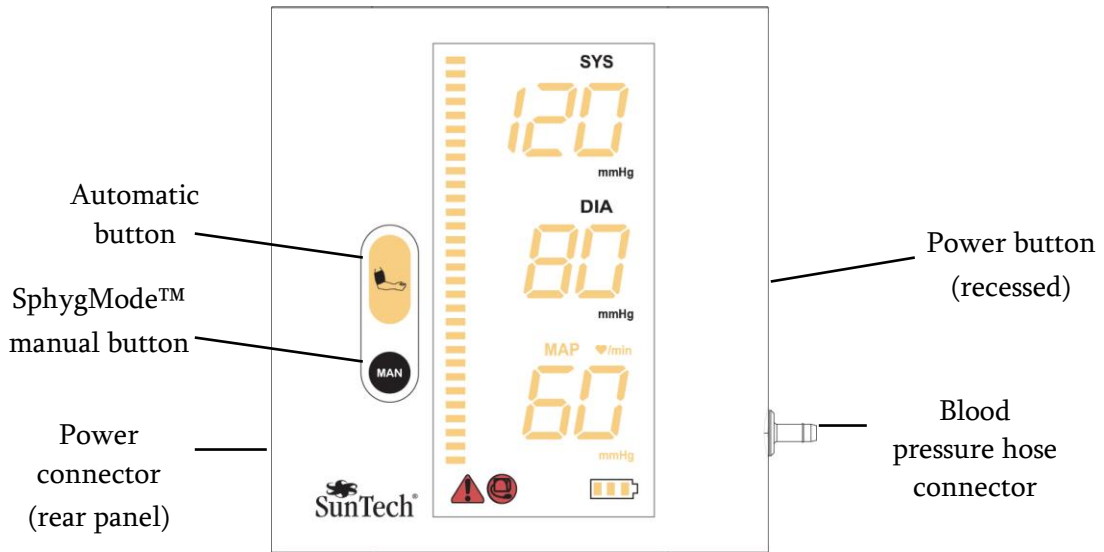



Connectors on the main BP module

- Power Connector: Connects to the power supply.
- Blood Pressure Hose Connector: Connects to the 8-foot pressure hose.

Buttons

The buttons are used for all actions on the interface, and provide tactile feedback when pressed.

Buttons on the main BP module

Button Functionality for the BP Module			
Button	Device Status	Action	Result
 Automatic	Idle	Select for less than 2 seconds	Start an automatic BP measurement.
		Select for 2 to 5 seconds	Redisplay last measurement values for all modules.
		Select for more than 5 seconds	Clear last measurement values for all modules.
	Taking an automatic <u>or</u> <i>SphygMode</i> BP	Select	Aborts the BP measurement in progress.
	In Calibration Check mode	Select	Device exits Calibration Check mode and is ready to take measurements.
 <i>SphygMode</i> Manual	Idle	Select	Inflates the cuff as long as the button is selected.
	Taking a <i>SphygMode</i> BP	Select	Re-inflates the cuff as long as the button is selected.
	Taking an automatic BP	Select	Aborts the BP measurement in progress.
	In Calibration Check mode	Select	Device exits Calibration Check mode and is ready to take measurements.
 Power	Power off	Select	Turns on the device.
	Power on	Select	Turns off the device.
Automatic + Power	Power off	Hold the Automatic button down while selecting the Power button.	Device enters the Calibration Check mode.
<i>SphygMode</i> Manual + Power	Power off	Hold the <i>SphygMode</i> button down while selecting the Power button.	Device enables/disables MAP mode.

BP display

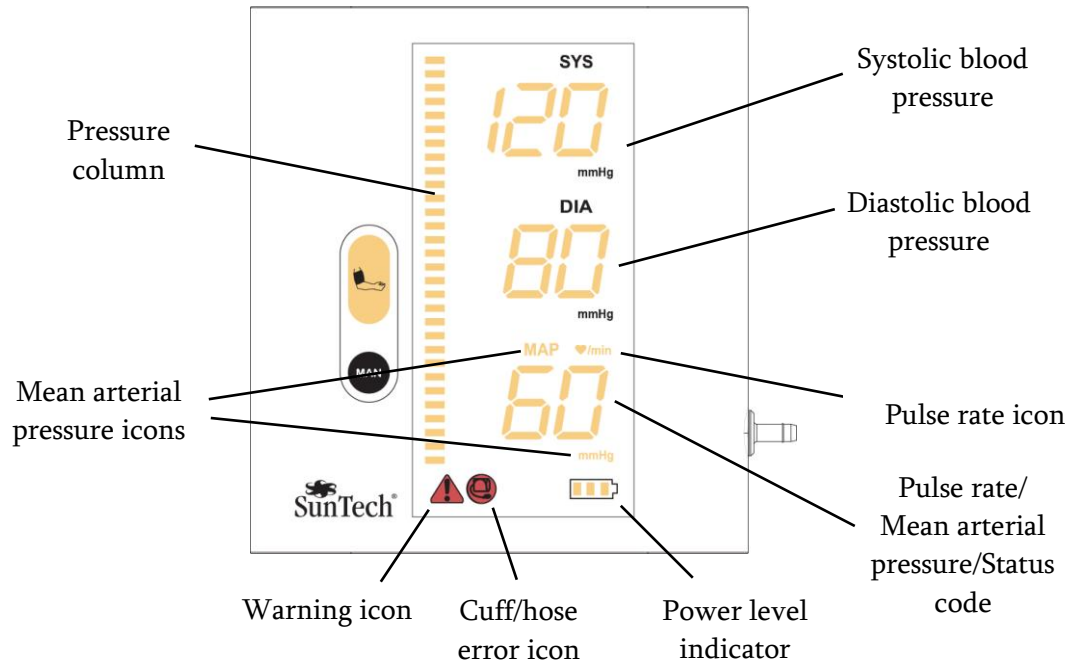

Information on the BP module display

- **Systolic blood pressure:** At the end of a measurement or when the last measurement is recalled, the patient's systolic BP is displayed. During a measurement, the cuff pressure is displayed.
- **Diastolic blood pressure:** At the end of a measurement or when the last measurement is recalled, the patient's diastolic BP is displayed.
- **Pulse rate/Mean arterial pressure (MAP):** At the end of a measurement or when the last measurement is recalled, the patient's pulse rate is displayed. When the MAP feature is enabled, MAP toggles with pulse rate. If the cuff/hose error and warning icons are lit, a status code may appear in this space. See page 41 for details.
- **Pulse rate icon:** When displayed, the value below is the patient's pulse rate.
- **Mean arterial pressure icon:** When displayed, the value below is the patient's MAP.
- **Power level indicator:** Displays connection to AC power or for the battery version, the charge level of the battery.
- **Cuff/hose icon:** When displayed, indicates that the cuff and/or pneumatic hose need to be checked and adjusted in order to take a measurement. See page 40 for details.

- Warning icon: When displayed, indicates that the system needs to be checked. See page 40 for details.
- Pressure column: Displays the pressure in the cuff. Each segment represents approximately 10mmHg.

Optional temperature and pulse oximetry modules

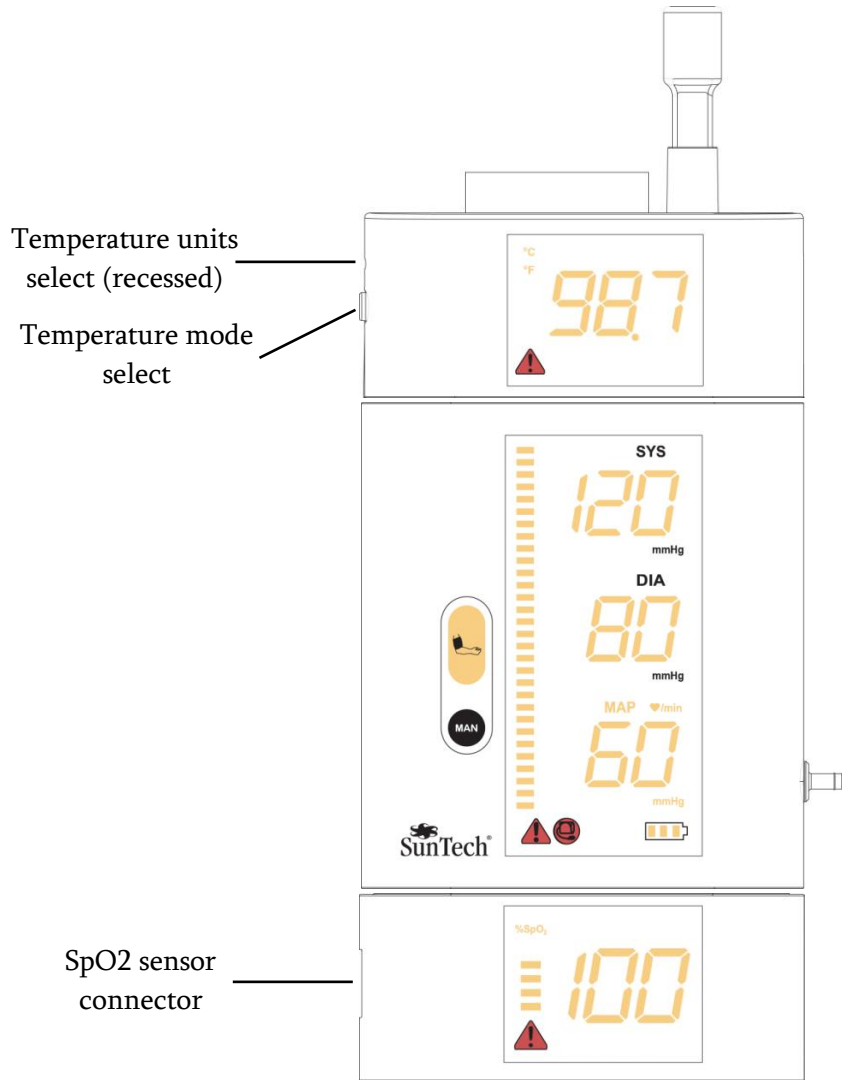

Buttons on the optional temperature module

- Temperature units select: Recessed momentary switch that toggles the display between °F and °C.
- Temperature mode select (symbol on button: ✓): Momentary switch that selects oral vs. axillary measurements for the oral temperature probe, and selects predictive vs. direct measurement methods for all probes.

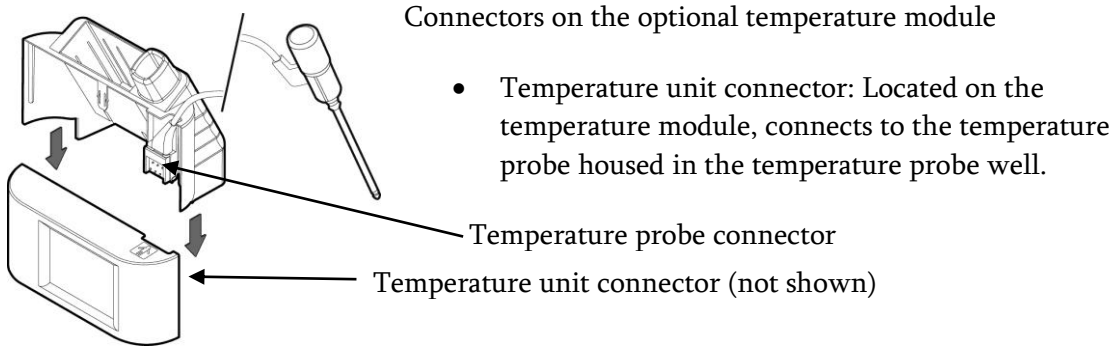

Buttons on the optional pulse oximetry module: None

Connectors on the optional pulse oximetry module

- SpO₂ sensor connector: Connects to an SpO₂ extension cable or sensor. See page 62 for compatible accessories.



All vSat™ SpO₂ modules can be identified by a blue label around the SpO₂ sensor connector. Only vSat™ SpO₂ sensors (blue sensor cable and connector) should be used with vSat™ modules.

All Nellcor®-compatible SpO₂ modules can be identified by a white label around the SpO₂ sensor connector. Only Nellcor®-compatible sensors should be used with Nellcor®-compatible modules.

Optional temperature and pulse oximetry displays

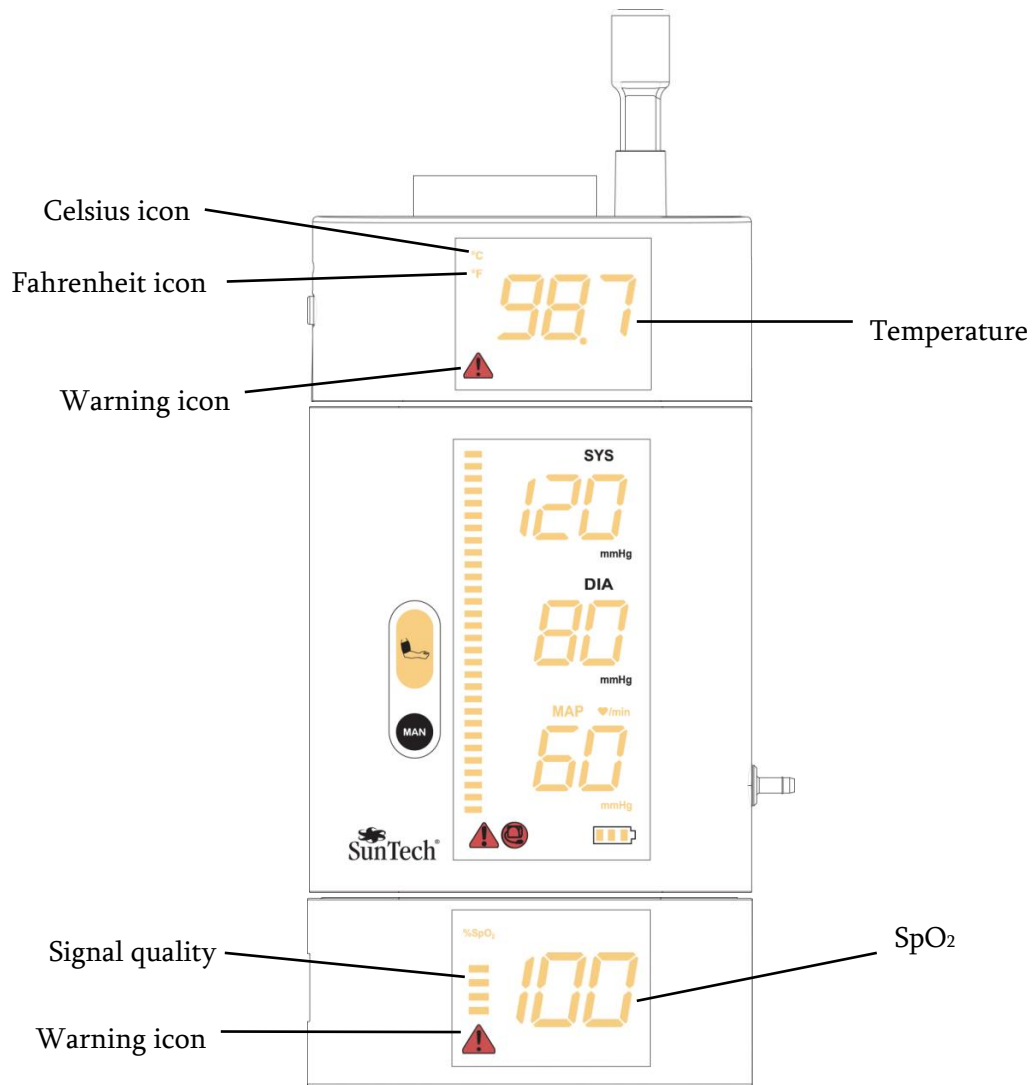

Information on the optional temperature module display

- **Temperature:** At the end of a measurement, the patient's temperature is displayed. During a measurement, displays the probe type and related information. If the warning icon is lit, displays the status code. See page 41 for details.
- **Celsius icon:** When lit, the value below is displayed in degrees Celsius.
- **Fahrenheit icon:** When lit, the value is displayed in degrees Fahrenheit.
- **Warning icon:** When displayed, indicates that the system needs to be checked. See page 41 for details.

Information on the optional pulse oximetry module display

- SpO₂: At the end of a measurement, the functional oxygen saturation of the patient is displayed. If the warning icon is lit, displays the status code. See page 42 for details.
- Signal quality: During a measurement, indicates the quality of signal from the pulse oximeter sensor.
- Warning icon: When displayed, indicates that the system needs to be checked. See page 42 for details.

Icons and Cues

Your *SunTech 247* is designed to provide unambiguous visual and auditory cues before, during and after a measurement. For easy reference, all cues are tabulated in this chapter.

- Audible cues, or beeps, identify stages in the measurement cycle.
- Icons illuminated within a module's display indicate measurement modes, processes or warnings.





Auditory Cues

The temperature and BP modules of the *SunTech 247* are programmed with auditory cues. A listing of these cues appears below.

NUMBER OF BEEPS...	INDICATES...
One short beep after power up or right before powering down	The device is powered up and ready use or the device is about to turn off.
One short beep after taking a measurement	Success – measurement taken.
Three short beeps	BP measurement error. Please check or take another measurement.
Three long beeps	A system error has occurred. Please refer to page 41 for troubleshooting.
One short beep followed by a long beep	You have aborted this BP measurement.

Visual Cues – Battery Icon





If your *SunTech 247* does not have a battery, all segments of the battery icon are lit when the power supply is connected. If your device has a battery, then the icon indicates the status of the power supply as follows.

ICON/DISPLAY	INDICATES...
	Battery fully charged
	Battery is charging (segments animated)
	Power-off state
	As the charge level drops, the segments will be turned off in sequence from the right to the left.
	The battery charge is very low. Recharge before using. (segment flashing)



Visual Cues – Blood Pressure Module





Icons and numeric displays on your device assist you in taking quick and accurate readings.

ICON/DISPLAY	INDICATES...
SYS	The systolic BP, read in mmHg, displays immediately below this symbol.
DIA	The diastolic BP, read in mmHg, displays immediately below this symbol.
mmHg	Unit of measurement for SYS, DIA, and MAP
 /min	Pulse rate, in beats per minute, displays immediately below this symbol.



ICON/DISPLAY	INDICATES...
	If this icon is lit on power-up, MAP mode is enabled. After a measurement, this icon is lit when MAP is displayed in the space below.
	These letters are displayed in the pulse rate display area when you are checking the device's calibration.
	Indicates an issue associated with the cuff, its position, or connection. Please check the cuff and hose and try again. Additionally, check page 40 for troubleshooting details.
	Warning! The device is unable to take a valid reading. See page 40 for troubleshooting details.
	A measurement is in progress. If the column is rising, the cuff is being inflated; if the column is falling, the cuff is deflating. Each segment lit is approximately equivalent to 10 mmHg.

Visual Cues – Temperature Module

ICON/DISPLAY	INDICATES...
°F	Temperature shown in degrees Fahrenheit.
°C	Temperature shown in degrees Celsius.
 “Traveling dash” in temperature display	The unit is taking a measurement in predictive measurement mode.
	Warning! There is an error in the measurement or module. Please check the status code in the troubleshooting section on page 41 for details and solutions.

ICON/DISPLAY	INDICATES...
	The device is set to measure an oral temperature.
	The device is set to measure an axillary temperature.
	The device is set to measure a rectal temperature.
	The unit is taking a measurement in direct measurement mode. The display of <i>dir</i> alternates with the current probe temperature.
Temperature value flashes	The unit is taking a measurement in direct measurement mode, but the reading is currently out-of-range.
Temperature value flashes in an upward direction	Final measurement is greater than 109.4°F/43.0°C.
Temperature value flashes in a downward direction	Final measurement is less than 86°F /30.0°C.
Temperature value is steady (no flashing)	This is the final temperature value.

Visual Cues – Pulse Oximetry Module

ICON/DISPLAY	INDICATES...
 “Traveling dash” in SpO ₂ display	The unit is taking a measurement.
	Warning! Indicates an error in the optional pulse oximetry module. Please refer to the troubleshooting section on page 42.

ICON/DISPLAY	INDICATES...
	<p>Indicates signal strength and quality from the pulse oximeter sensor. If there is no measurement and the signal quality is low, try a different site or sensor.</p>
<p>SpO₂ value</p>	<p>Indicates the functional oxygen saturation. This area also displays the status code when the warning symbol is lit.</p>

QUICK START GUIDE

If the device is off, turn it on by depressing the power button on the right side.

Measuring Blood Pressure and Pulse Rate Automatically

1. Wrap an appropriately sized cuff (sizes are tabulated on page 21) snugly around the upper arm midway between the elbow and shoulder.
2. Ask the patient to stay still and quiet before taking the measurement.





3. Press the automatic button on your unit. The cuff begins to inflate and the cuff pressure is shown in the systolic display.
4. In about 30-40 seconds, depending on the size of the cuff, you will hear a beep to indicate cycle completion. The systolic and diastolic values are shown in their respective locations. If MAP mode is enabled, the pulse rate and MAP values will alternate.

Measuring Blood Pressure Using *SphygMode*

1. Wrap an appropriately sized cuff (sizes are tabulated on page 21) snugly around the upper arm midway between the elbow and shoulder.
2. Ask the patient to stay still and quiet.
3. Press and hold the *SphygMode* manual button  to inflate the cuff. Watch the pressure displayed and release the button to start deflating the cuff at 3 mmHg/sec. Place your stethoscope on the brachial artery to take a *SphygMode* measurement.



If you see the  cuff and/or warning icon , you will need to take another measurement. Please refer to the troubleshooting section on page 40.

Measuring Temperature

1. To measure temperature orally, remove the blue probe from its holder and secure a disposable cover on it. The display shows the type of measurement, *orL*.
2. Wait for the device to beep before placing the probe carefully under the patient's tongue as denoted by the heat pockets shown to the right. The posterior medial sublingual pocket is preferred for accuracy. Hold the probe in place so that its tip maintains tissue contact. Close the patient's mouth. During measurement, a "traveling dash"  is displayed. In approximately 10-15 seconds, you will hear a long beep and the temperature reading will display.
3. Remove the probe from the patient's mouth, discard the probe cover by pressing the button on the end of the probe handle and replace the probe in its holder, ready for the next measurement.

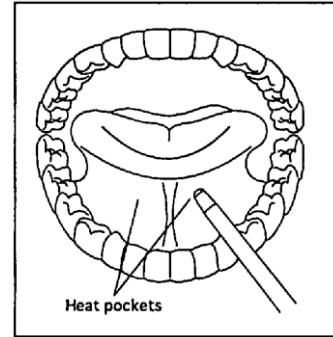

Measuring Oxygen Saturation

1. For the reusable finger sensor, insert the patient's digit, index most preferable, into the sensor. You will see a "traveling dash" until a valid reading is available, typically in 10-20 seconds. This reading is displayed along with the signal strength.

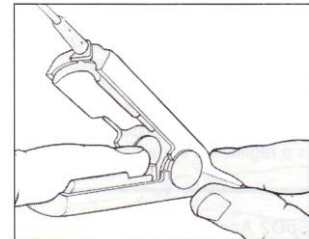

When selecting a sensor site, give priority to an extremity free of an arterial catheter, blood pressure cuff or intravascular infusion.

2. Detach the sensor carefully and replace it in the basket. At the end of the measurement, the last valid reading will flash for 8 seconds and then be displayed for two minutes or until the next measurement.

SETTING UP THE *SUNTECH 247*

Safety Precautions

As a clinically trained professional using the *SunTech 247*, your responsibilities include safeguarding your patients, yourself and your equipment. Many setup functions will be performed either only once or very occasionally, and it is important that you pay close attention. Before you set up your *SunTech 247*, please review these safety guidelines.

Protecting Your Patient

- While your *SunTech 247* is designed for accurate, reliable vital signs measurement for adults and children, it is not to be used on patients connected to cardiopulmonary bypass machines, patients needing continuous monitoring, or patients under three years of age.
- If you feel that a particular blood pressure reading is questionable, use the *SunTech 247* and your stethoscope to take a second, Sphygmode reading. If you would like confirmation for an SpO₂ or temperature reading, please use an alternate device. After taking confirmatory readings, check the device for proper functioning.
- Arrange the power supply and cabling so that it does not constitute a hazard to your patient, your co-workers or yourself.

Protecting Yourself

- Removing the cover or the back of the device can cause electric shocks. Do not attempt to service your *SunTech 247* unless you are authorized.

Protecting Your *SunTech 247*

- Do not use your *SunTech 247* around flammable substances.
- Use only *SunTech* approved accessories to power your *SunTech 247*. A listing of these is in the Appendix on page 61.
- Use only those batteries supplied by *SunTech* or an authorized service representative.
- The *SunTech 247* must be placed on a stable, slip proof surface. Only recommended hardware should be used to mount your device to a wall, pole or tabletop carrier.
- At no point should the contents of the storage basket exceed five lbs. in weight.
- Do not immerse the device in water or attempt to gas sterilize or autoclave it.
- The reliability of your *SunTech 247* depends upon conformance with the operation and service instructions as detailed in this manual.

Mounting Your Device

For convenience, you may mount your unit on the wall or attach it to a mobile stand or a tabletop stand. A storage basket is included and can be used to hold cuffs, boxes of probe covers for the optional temperature module, and SpO₂ sensors for the optional pulse oximetry module. All compatible accessories for mounting your *SunTech 247* can be found in the list starting on page 61. All versions of the *SunTech 247* can be mounted in the following ways:

Mounting the Device on a Wall

Mount the *SunTech 247* on the wall in place of an aneroid manometer. To affix your *SunTech 247* to the wall:

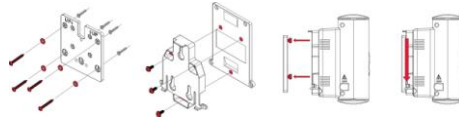

1. Attach the bracket to the wall using 4 wall screws, and the basket using 2 screws.
2. Attach the wall bracket adapter to the rear panel of the BP device using the 3 screws.
3. Position the adapter onto the rivets of the wall bracket and slide the device down until it locks into place.



The weight of the contents of the wall-mounted storage basket should never exceed five pounds. Please do not store heavy items in the storage basket.

Affixing the Device to a Mobile Stand

Attaching the *SunTech 247* to a mobile stand facilitates portability. To mount the *SunTech 247* to the mobile stand:

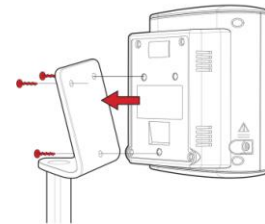

1. Assemble the mobile stand according to the manufacturer's directions.
2. Using the three thumb screws, secure the rear panel of the BP device to the stand.

Placing the Device on a Tabletop

Use the *SunTech 247* with the tabletop stand to make it easier to carry with you. To mount the *SunTech 247* to the tabletop stand:

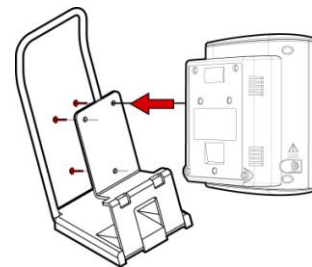

1. Using the three thumb screws, secure the rear panel of the BP device to the stand.



First-Time Setup



The *SunTech 247* must be plugged in and charged before first use.

Charging the Battery

The *SunTech 247* Battery is powered by a rechargeable 6V lead-acid battery or by AC power. To turn the device on for the first time, connect the device to the power supply, then the power supply to an AC mains power source. Leave it connected for 8 to 12 hours to fully charge the battery.

The charging status is indicated by the rotating sequence of lit segments  in the battery icon. When the battery is fully charged, all segments will be lit . A fully charged battery provides enough power for the device to make at least 200 measurements within a 12-hour period. The battery is guaranteed to last for 200 readings in an 8 hour period per charge.

Connecting Your Device

To maintain the easy readability and streamlined facade of your *SunTech 247*, all connections are made through the back or sides of the enclosure.

Connectors on the BP enclosure are for:

- Blood pressure hose
- Power supply

Connectors on the optional modules are for:

- A pulse oximetry sensor on the pulse oximetry module
- A temperature probe on the temperature module

To connect the *SunTech 247*:

1. For blood pressure measurements, the blood pressure hose should already be attached to the BP device. If not, push the open end of the blood pressure hose (one without the plastic connector) over the blood pressure hose connector on the module. Secure the end with the plastic connector to an appropriately sized cuff by twisting the two mating connectors together.
2. For temperature measurements, remove the tape holding the temperature probe in the well, and place the box of probe covers in the well next to the probe.

3. For SpO₂ measurements, attach the pulse oximetry sensor or extension cable to the connector on the module, making sure the retention clip is pushed towards the front of the unit. Once the sensor/cable connector is inserted, push the clip backward over the connector to hold it securely in the module.



All vSat™ SpO₂ modules can be identified by a blue label around the SpO₂ sensor connector. Only vSat™ SpO₂ sensors (blue sensor cable and connector) should be used with vSat™ modules.

All Nellcor®-compatible SpO₂ modules can be identified by a white label around the SpO₂ sensor connector. Only Nellcor®-compatible sensors should be used with Nellcor®-compatible modules.

4. Connect the power supply to the main BP module. Then, connect the power supply to an AC mains power source. The device will turn on automatically.

Powering Up

1. Depress the power button located on the right side of the main enclosure. The power-up sequence begins. All display segments light up for three seconds. A short beep indicates that the *SunTech 247* is ready.
2. Check the status of the power level indicator. If the power level indicator shows one segment flashing, connect the device to the power supply before using. You are now ready to use your *SunTech 247*.

Selecting Temperature Unit of Measurement

With the device powered on, select the unit of measurement for temperature by depressing the recessed button on the side of the temperature module to toggle between the °C and °F icons. The selected icon will be lit in the display and becomes your default selection.

Bluetooth® Wireless Communication

If your *SunTech 247* has the optional Bluetooth® wireless communication capability, please contact your IT administrator for configuration with your EMR/HER system or communication network.

MEASURING BLOOD PRESSURE WITH THE *SUNTECH 247*

Your *SunTech 247* device is designed to take accurate blood pressure readings by the oscillometric method. Systolic pressures from 60 to 270 mmHg and diastolic pressures from 30 to 170 mm Hg lie within the range of your device. In most cases, you will be able to take accurate blood pressure (BP) and pulse rate (HR) measurements within 30-40 seconds.

Steps in taking a BP measurement are:

- Prepping the patient and attaching the cuff
- Taking the measurement

Prepping Your Patient

Ensure that the patient:

- Is not wearing any constricting clothing on the selected arm.
- Has no injury or tissue damage on the selected arm.
- Keeps the cuffed arm at heart level.
- Keeps the cuffed arm motion-free and relaxed without any muscle tension in the biceps and triceps during the measurement.
- Does not cross his/her legs for the measurement.

Keep aware of current practices as recommended by the American Heart Association, British Hypertension Society, and other medical practice associations.

1. Ready the patient into a sitting , standing , or supine  position. Remember that a patient's BP can vary with position.













The stress of being in a clinical situation often causes patients to undergo 'white coat hypertension,' leading to higher-than-normal readings. Help your patient to relax as you prepare to take the measurement.

Selecting the Right Cuff

Your device comes with durable two-piece All Purpose Cuffs (APC) from *SunTech Medical, Inc.*. Cuffs are available in a range of sizes, from *Child* to *Thigh*. Note that your *SunTech 247* works optimally with APC cuffs.

Using the table below, select a cuff you estimate to be of the right circumference:

	Child	12 - 19 cm
	Child Long	12 - 19 cm
	Small Adult	17 - 25 cm
	Small Adult Long	17 - 25 cm
	Adult	23 - 33 cm
	Adult Long	23 - 33 cm
	Large Adult	31 - 40 cm
	Large Adult Long	31 - 40 cm
	Thigh	38 - 50 cm

2. Wrap the cuff around the patient's upper arm midway between the elbow and the shoulder.
3. Ensure the **ARTERY** arrow is over the brachial artery, between the biceps and triceps muscles on the inside of the arm.
4. Use the range indicator  and the **INDEX** line on the inside of the cuff to check that the arm circumference falls within the specified range of the cuff. If the arm is within range, this cuff size is correct for your patient. If the measurement is outside the **RANGE** indicator, use the appropriate larger or smaller cuff and re-check.



Using a cuff that is too small, commonly called undercuffing, can result in overestimating a patient's BP. Using a cuff that is too large, or overcuffing, can result in underestimating a patient's BP. For most accurate results, take care in selecting the appropriate size cuff for your patient.

5. Ensure that the BP pressure hose is connected to the cuff. Confirm that the hose is neither compressed nor kinked.
6. Ask the patient to stay still and quiet before taking the measurement.



Do not place the cuff on an arm currently being used for other procedures such as intravenous infusions or oximetry readings.

Taking a Measurement

The *SunTech 247* allows you to take BP measurements automatically like a monitor or manually like a sphygmomanometer using manual *SphygMode*.

In automatic mode, the cuff inflates and deflates automatically. Initial inflation reaches a cuff pressure of 160 mmHg; the cuff then re-inflates as necessary to obtain a reading. Deflation is optimized to reduce measurement time and obtain an accurate result.

In manual *SphygMode*, you inflate the cuff manually using the *SphygMode* MAN button in place of an inflation bulb of a sphygmomanometer. When you release the *SphygMode* MAN button, the cuff automatically deflates at the AHA recommended rate of 3mmHg/sec. Simply use your stethoscope to determine your patient's blood pressure.

Taking an Automated Measurement

1. With the patient prepped as described earlier (page 20), and the device powered on, depress the automatic button that is located in front of the BP module and denoted



by the cuffed arm icon . The cuff inflates to approximately 160 mmHg, as indicated in the systolic area of the display.

2. Once the cuff pressure reaches its target, the device controls the deflation and, in some instances, re-inflation of the cuff in order to accurately measure BP. The cuff pressure displays in the systolic area and is also indicated by the vertical LED bar to the left. When you hear a single short beep, indicating the end of the measurement cycle, read the systolic and diastolic pressures, displayed under the SYS and DIA symbols, and the pulse rate, displayed under the /min symbol.



Want a MAP reading?
NOTE: Not available in the US

By default, your *SunTech 247* measures systolic and diastolic BP, and HR. To obtain a Mean Arterial Pressure (MAP) reading, hold down the

SphygMode manual button  as you toggle power to *on*. On power up, the MAP icon lights up on the LED display. Now, once measurements are complete, the display will alternate between HR and MAP. To exit MAP mode, power the device off and again hold down the *SphygMode* manual

button  as you toggle power to *on*. On power up, the MAP icon will flash and disappear. MAP will no longer be displayed.

3. If there is an error in obtaining a measurement, indicated by three beeps, please refer to the troubleshooting tips on page 40 and take the appropriate remedial measure.



Taking a measurement on each arm helps rule out dissecting aneurysms, coarctation of the aorta, vascular obstruction and possible errors in measurement.¹

You can find more tips like this in the American Heart Association's current scientific statement on recommendations for blood pressure measurement.

Taking a Manual *SphygMode* Measurement

1. With the patient prepped as described earlier (page 20), and the device powered on, palpate the brachial artery at the antecubital fossa. Place your stethoscope over this space.
2. Press and hold the *SphygMode* manual button  until you inflate the cuff to a level at least 30 mmHg higher than the patient's systolic pressure.
3. Once the cuff has been inflated to the desired level, release the *SphygMode* manual button. The cuff begins to deflate at approximately 3mmHg/sec and the device displays the cuff pressure.
4. While listening to your stethoscope, note the systolic and diastolic pressures corresponding to the first and last Korotkoff sounds (K-sounds) heard.



Press the *SphygMode* manual button  to re-inflate the cuff.



Press the automatic button  if you need to rapidly release all the air from the cuff.

¹ Circulation. AHA Scientific Statement: Recommendations for Blood Pressure Measurement in Humans and Experimental Animals, Part 1: Blood Pressure Measurement in Humans: A Statement for Professionals From the Subcommittee of Professional and Public Education of the American Heart Associations Council on High Blood Pressure Research. Thomas G. Pickering, MD, DPhil; John E. Hall, PhD; Lawrence J. Appel, MD; Bonita E. Falkner, MD; John Graves, MD; Martha N. Hill, RN, PhD; Daniel W. Jones, MD; Theodore Kurtz, MD; Sheldon G. Sheps, MD; Edward J. Roccella, PhD, MPH, 2005;111:697-716.

K-Sounds: A Primer

Korotkoff sounds, commonly called K-sounds, are the sounds you detect through your stethoscope when you measure blood pressure with a sphygmomanometer or an aneroid device. Named for the Russian physician who identified them, there are five phases of K-sounds, each phase characterized by a distinct volume and quality of sound.

K-sounds are heard through the stethoscope as the blood pressure cuff deflates. The first sound, K-1, is heard when cuff pressure equals systolic pressure. K-1 is a sharp, tapping sound.

The K-2 phase is characterized by a swishing sound, caused by the swirling currents in the blood as the flow through the artery increases.

In the K-3 phase, there is a resumption of crisp tapping sounds, similar to those heard during phase 1.

An abrupt muffling of sound identifies K-4, the fourth phase.

The end or fifth phase is the point at which sounds cease to be heard altogether.

Systolic pressure is registered at K-1 and diastolic at K-5.



K-4 or K-5? There exists some debate about whether K-4 or K-5 should be recorded as the diastolic BP. In most cases, K-5 is preferred. However, if the sound persists even after the cuff is completely deflated, it is recommended that K-4 be recorded as the diastolic blood pressure.²

You can find more tips like this in the British Hypertension Society's current guidelines for management of hypertension.

² B Williams, NR Poulter, MJ Brown, M Davis, GT McInnes, JF Potter, PS Sever, S McG Thom, British Hypertension Society Guidelines, Guidelines for management of hypertension: report of the fourth working party of the British Hypertension Society 2004 – BHS IV, Journal of Human Hypertension, 2004 18, 139-185.

MEASURING TEMPERATURE WITH THE *SUNTECH 247*

Your *SunTech 247* device can measure temperature with the optional temperature module. This module enables you to take rapid, accurate temperature measurements ranging from 86°F-109.4°F. Typically, predictive readings are obtained within ten to fifteen seconds, and direct readings within two minutes. The module is equipped with the temperature probe for oral/axillary measurement, color-coded blue. A rectal probe that is color-coded red is optionally available.

Temperature Units of Measurement

The device displays the temperature measurement in:

- Celsius
- Fahrenheit

To choose a unit of measurement, depress the recessed button on the left side of the temperature module. The icon for the selected unit is illuminated. This is now the default selection.

Temperature Measurement Modes

The device can measure temperature via three modes:

- Oral, indicated by *orL* on the display and measured using the blue probe
- Axillary, indicated by *axL* on the display and measured using the blue probe
- Rectal, indicated by *rec* on the display and measured using the red probe

All three modes can be used for both predictive and direct measurement. In the default predictive mode, your *SunTech 247* predicts temperature in 10-15 seconds with an accuracy of +/- 0.2 °F (+/- 0.1°C). When a fever is detected, the measurement may last longer. In direct mode, the display continually updates until a stable reading is reached. This mode is used in certain difficult conditions when a predictive reading is not preferred or possible.



Axillary and rectal modes are preferred for children and compromised patients.

Using temperature probe and probe covers

In addition to the safety instructions for your *SunTech 247*, here are some additional tips on using the probe and probe covers for the optional temperature module:

- Use only FILAC™ FASTEMP™ probe covers with this device.
- The device and probe covers are non-sterile. Do not use on abraded tissue.
- To limit cross contamination, use blue probes for taking oral and axillary temperature only. Use red probes for rectal temperatures only.
- Dispose used probe covers in accordance with current medical practices or local regulations regarding disposal of infectious, biological medical waste.
- Note that proper placement of the probe is essential to the accuracy of the measurement.

Taking an Oral Temperature

1. Remove the blue probe from its holder and secure a disposable cover on it. The probe pre-heating process begins with the flashing display of the type of measurement, **ORL**.
2. After a few seconds, the device will beep to signify that the probe is ready for placement. After the beep, place the probe carefully under the patient's tongue as denoted by the heat pockets shown to the right. The posterior medial sublingual pocket is preferred for accuracy. Hold the probe in place so that its tip maintains tissue contact. Close the patient's mouth. During measurement, a "traveling dash"  is displayed.
3. After 10-15 seconds, a long beep signals the end of the measurement cycle. The temperature will display for two minutes or until you initiate a new measurement.
4. Remove the probe from the patient, discard the probe cover by pressing the end of the probe handle, and return the probe to the probe holder. Note the temperature reading.

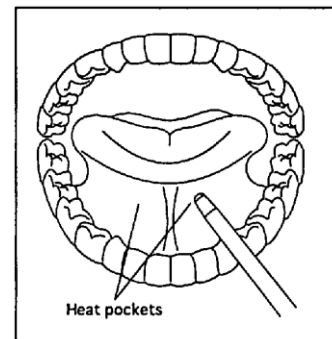

By default, the predictive method is selected. To select direct measurement from the start, press the temperature mode select button located on left side of the temperature module for three seconds or until you hear two short, quick beeps. When using direct measurement, the display will alternate displaying "dir" and the current probe temperature. A long beep signals the final temperature result.

Taking an Axillary Temperature

1. Remove the blue probe from its holder and secure a disposable cover on it. The probe pre-heating process begins with the flashing display of the type of measurement, *axL*.
2. Briefly (less than 2 seconds) press the temperature mode select button until it displays *axL* for axillary.
3. After a few seconds, the device will beep to signify that the probe is ready for placement. After the beep, lift the patient's upper arm and place the probe high under the patient's axilla. Apply pressure gently to assure good contact between the probe and axilla, and make sure there is no interference such as clothing. Hold the probe in place so that its tip maintains tissue contact. Place the arm by the patient's side. During measurement, a "traveling dash"  is displayed.

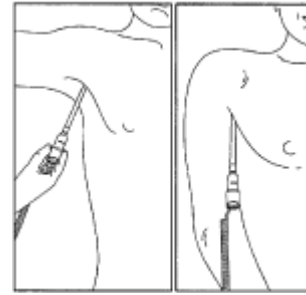

Note that proper placement of the probe is essential to the accuracy of the measurement.

4. After 10-15 seconds, a long beep signals the end of the measurement cycle. The temperature will display for two minutes or until you initiate a new measurement.
5. Remove the probe, discard the probe cover and place back in the probe holder. Note the temperature reading.

Taking a Rectal Temperature

1. Remove the blue probe and well by sliding the pieces upward until they detach.
2. Place the red probe in the holder of the red well and the probe connector in the notched space as shown to the right (see page 37 for detailed instructions). Slide the red well vertically onto the back of the module thus replacing the blue well.

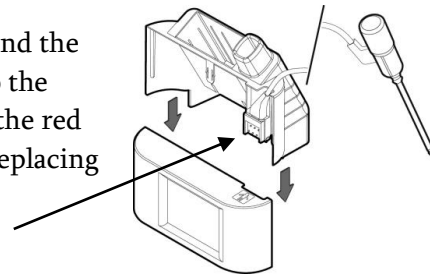

Notched space/ Probe connector

3. Assist patient into a prone (facedown) position and ensure that the patient is relaxed.

4. Remove the red probe from its holder and secure a disposable cover on it. The probe pre-heating process begins with the flashing display of $r\text{EC}$.
 5. After a few seconds, the device will beep to signify that the probe is ready for placement. After the beep, separate the patient's buttocks and apply a thin coat of water-based lubricant for smooth entry of the probe. Insert the probe gently 1 cm inside the sphincter. Tilt the probe to keep it in place and hold it in position to ensure tissue contact. During measurement, a "traveling dash"  is displayed.
-



Note that proper placement of the probe is essential to the accuracy of the measurement.

6. After 10-15 seconds, a long beep signals the end of the measurement. The result will be displayed for two minutes or until you initiate a new measurement.
 7. Remove the probe, discard the probe cover and place back in the probe holder. Note the reading.
-



If the temperature reading is out of range, the device will beep and flash the limit that is exceeded. So, if the reading is greater than 109.4°F (43.0°C), "109.4" or "43.0" will flash on the display followed by a sequence of rising LED's. If the reading is less than 86.0°F (30.0°C), "86.0" or "30.0" will flash on the display followed by a sequence of falling LED's.

MEASURING OXYGEN SATURATION WITH THE *SUNTECH* *247*

The *SunTech 247* optional pulse oximeter modules measure functional oxygen saturation ranging from 40% to 100%. A signal strength display assists the clinician in the proper placement of the sensor.



The *SunTech 247* is a spot check device and is not used for patient monitoring. Therefore, there are no SpO₂ alarms.

Steps for measuring functional oxygen saturation:

- Prepping the patient and affixing the sensor
- Taking a reading

Prepping the Patient

Selecting the Right Sensor

Your choice of sensor is affected by many factors including:

- Patient's body weight
 - Patient activity
 - Infection control concerns
-



For most patients greater than 30kg, use an adult sensor; for patients 10-50kg, a pediatric sensor may provide better fit.

Disposable sensors can provide a more secure connection to the patient.

Protecting Your Pulse Oximetry Sensors

In addition to the safety instructions for your *SunTech 247*, here are some additional tips on caring for the sensors of the optional pulse oximetry modules:

- To prevent damage, do not autoclave or immerse the sensor in liquid.
- For peak performance and accurate measurements, do not expose the sensors to excessive ambient light, electromagnetic interference, dysfunctional hemoglobin, low perfusion, intravascular dyes, finger nail polish and long or artificial finger nails.

- Do not use a damaged sensor as it may cause patient injury or equipment failure.
- The use of this sensor is contraindicated in patients with allergies to adhesive tape.

Guidelines for Use

- When selecting a sensor site, give priority to an extremity free of an arterial catheter, blood pressure cuff or intravascular infusion line.
- Clean reusable sensors after use.
- Ensure that the optical components of the sensor are properly affixed to the patient and aligned.
- Artificial nails, or dark shades of nail polish, may reduce light transmissions and affect pulse oximetry accuracy. Clean off nail polish or detach artificial nails before applying the sensors.
- Secure sensor cable firmly but lightly at the base of the finger.
- Inspect the sensor application site at least every 6 to 8 hours to ensure correct sensor alignment and skin integrity. Patient sensitivity may vary due to medical status or skin condition. Discontinue use of adhesive tape strips if the patient exhibits an allergic reaction to the adhesive materials.

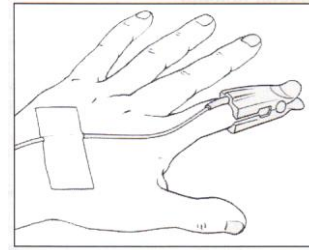



Measuring Oxygen Saturation with Sensor on Finger

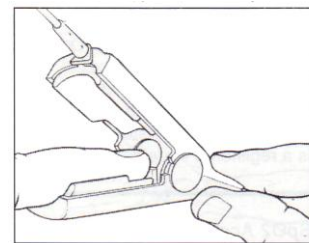

For best results, clip the sensor on the index, middle or ring finger, avoiding the little finger or thumb.

1. For the reusable finger sensor, insert the patient's digit, index most preferable, into the sensor. Ensure that the tip of the digit touches the rear guide posts of the sensor and the sensor cable extends along the top of the patient's hand. For disposable finger sensors, place one sensor paddle on top of the finger, and the other on the bottom of the same finger. Secure sensor with wrap, tape or bandage.



SpO₂ measurement will begin automatically. Once the SpO₂ determination begins, a “traveling dash”  will be displayed until a measurement is determined, usually in 10-20 seconds. This reading will be updated once per second. SpO₂ can be measured without interruption for up to 10 minutes. Along with the functional oxygen saturation value, the signal strength will also display.

2. When you remove the sensor from the patient's finger, the display will flash the last measurement for 8 seconds. The measurement will then be displayed for 2 minutes or until another measurement is made. Note the patient's reading and confirm normal venous return.

Measuring Oxygen Saturation with a Earlobe Sensor

1. Rub the earlobe vigorously for five seconds to stimulate blood flow. Place ear clip sensor onto earlobe, so that the detector side (identified by raised dot on back of paddle, or on one-piece ear clip, the side opposite the cable) is behind the earlobe. Press sensor paddles into measurement site once to ensure firm sensor placement.

The SpO₂ determination will begin. Once the SpO₂ determination begins, a "traveling dash"  will be displayed until a measurement is determined, usually in 10 seconds. This reading will be updated once per second. SpO₂ can be measured without interruption for up to 10 minutes. Along with the functional oxygen saturation value, the signal strength will also display.

2. Note the patient's reading and remove the clip gently. When you remove the sensors from the patient's ear, the display will flash the last measurement for 8 seconds. The measurement will then be displayed for 2 minutes or until another measurement is made. Note the patient's reading and confirm normal venous return.



After 10 minutes of continuous measurement, the measurement is automatically terminated and status code "01" is displayed. To view the last measurement prior to automatic termination, press and hold the

automatic button  for more than two seconds (see page 32 for details).

MANAGING READINGS

Recalling the Last Set of Readings

To redisplay the last set of readings, depress the automatic button  on the BP module for more than two seconds until the last reading is displayed. If your *SunTech 247* has temperature and/or pulse oximetry modules, the last set of readings includes these readings as well. If the last attempted reading resulted in an error and/or warning, then this will be displayed. The device will display dashes if no reading is in memory, a reading was aborted or, the previous BP was a *SphygMode* measurement.

For the pulse oximetry module: In the event of the 10-minute measurement timeout, the module will terminate the measurement and status code “01” will display on the main module. The last valid reading recorded at the end of the ten-minute period will be the recalled reading.

Clearing the Last Set of Readings

To clear the values from the last automatic BP measurement and the accessories, press and

hold the automatic button  more than 5 seconds. Previous values will be displayed momentarily. Then the display blanks. On redisplay you will see dashes for all the values that have been cleared.



Your *SunTech 247* displays the most recent set of readings for two minutes. If patient privacy is a concern, you can clear these readings from the display before collecting vital signs from another patient.

Bluetooth[®] Wireless Transmission of Readings

If your *SunTech 247* has the optional *Bluetooth*[®] wireless communication capability you may be able to transmit the readings into your EMR/EHR system or communication network. Contact your IT administrator or EMR/EHR vendor for support on configuring your *SunTech 247* for *Bluetooth*[®] wireless communication.

MAINTAINING THE *SUNTECH 247*

Routine Maintenance

Establishing simple care guidelines helps protect the performance and life of your *SunTech 247*. On a routine basis, you should inspect the device, cables and pneumatic hoses for cracks, fraying or kinks and immediately replace any damaged parts.

Remember to check the calibration of the BP module every two years. If available, a biomedical technician may help in maintaining your equipment.

Cleaning

Cleaning the Device

1. Wipe the device with a soft, damp cloth to remove surface dust and dirt.
-



The *SunTech 247* device cannot be sterilized.



Never immerse the device in any fluid or attempt to employ cleaning fluids or solvents.

Cleaning the Cuffs

1. Between uses, wipe cuff sleeves and the insides of cuffs with a medical grade cleaning agent.
2. Periodically, remove the bladders and machine-wash the cuffs in cold water.
3. Line dry.

Cleaning the SpO₂ Sensors

1. Clean sensors and clips with a soft cloth dampened with water, a mild soap solution, or isopropyl alcohol.
2. Remove all tape residues by rubbing off.

3. Dry sensors and clips thoroughly before re-use.
-





Never immerse sensors and clips in fluids. Do not pour or spray any liquids on them either. Caustic or abrasive cleaners will cause permanent damage.



Prying the finger clip sensor to an angle greater than 90° can permanently damage its casing.

Checking the Calibration of Your Device

It is recommended that you check the BP calibration of your *SunTech 247* every two years. To check calibration:

1. Start with the device powered off. While holding down the automatic button  on the front of the BP module, toggle on the power button on the right side of the main enclosure. The “CAL” message is displayed in the pulse rate display to indicate that the system is in the calibration mode. During this mode, the system pressure displays in the systolic BP display area.
2. Using a T-connector, connect a calibrated pressure reference and control, such as a manometer and inflation bulb, to the pressure hose connector of the *SunTech 247*. Contact SunTech Medical customer support for details on ordering the calibration kit which includes a T-connector.
3. Compare the pressure reference to the *SunTech 247* throughout the pressure range, 0 to 270mmHg. If the difference between the pressure reference and the *SunTech 247* is no larger than 2mmHg, the *SunTech 247* is calibrated correctly for operation. If the *SunTech 247* needs calibrating, contact an authorized service center on page 46.
4. Exit the calibration check by pressing the automatic button  again. Once the display shows dashes as the systolic BP, you are now ready to take a measurement.

It is recommended that you check the temperature calibration of your *SunTech 247* temperature module annually. A FASTEMP™ Calibration Plug (see page 61 for details) is available to check accuracy of the FILAC™ FASTEMP™ technology. It replaces the regular probe and verifies the accuracy of the temperature electronics. Replace the temperature module if error is greater than +/-0.1 C. To check the calibration:

1. Remove the Temperature Well from the Temperature Module.
2. Replace the Temperature Probe with the Calibration Plug.
3. Replace the Temperature Well.
4. Initiate a measurement by inserting and removing the Temperature probe from the well.
5. Verify the accuracy of the measurement.

Probe accuracy can be checked by using the thermometer as you would on a patient in any mode with a cover, but place it in a calibrated water bath. Direct mode is accurate to +/- 0.1 C of the calibrated water bath temperature. Predictive mode accuracy is accurate to +/- 0.2 C of the calibrated water bath temperature.

Replacing the Rechargeable Battery

Replace the battery:

- According to your regular maintenance schedule.
- When the battery no longer charges.
- After heavy use, if necessary.

To replace the battery:

1. Remove the four screws securing the battery bay door.
2. Carefully remove the battery from the battery bay, being careful not to pull on the wires attached to the battery terminals.
3. Disconnect the wires from the battery terminals.
4. The rechargeable battery contains lead. Please dispose of the old battery properly.
5. Connect the wires to the terminals of the replacement battery, ensuring the red wire is attached to the red terminal and the black wire to the black terminal. If the wires are reversed, no damage will occur, however the *SunTech 247* will not operate. Be sure to use *SunTech* part number 17-0014-00 for the replacement battery in order to maintain optimum performance.
6. Re-secure the battery bay door with the four screws removed in step 1.
7. Connect the power supply to turn the device on and charge the replacement battery fully before using.



If the rechargeable battery is disconnected for any reason, the device must be connected to AC mains power via the power supply before the unit will turn on; this is required even if the battery has been properly reconnected.

Disposal



This symbol indicates the device contains materials (such as electrical components) which are hazardous. Please return to *SunTech Medical* for disposal.

Attaching the Temperature Module

Should you need to attach or remove the temperature module, the following instructions give an overview of its attachment to the BP module. The temperature module attaches to the top of the BP module. It is made up of the following two pieces:

- Part A with the display.

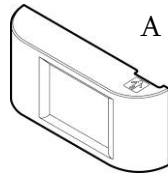

- Part B, the probe holder, which holds the temperature probe and probe cover box.

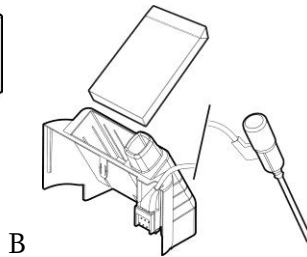

1. Using the power button on the right side of the BP module, ensure that the *SunTech 247* is off.

2. Remove the cover plate from the top of the BP module.

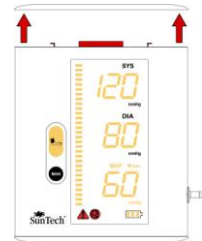

3. Slide part A of the temperature module along the guides on the top of the BP module from front to back until it snaps into place. All the segments of the temperature module display will light when the modules have been connected correctly.

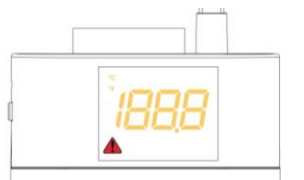
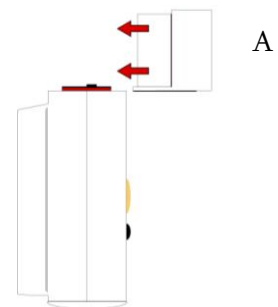

- Attach the temperature probe connector to part B as follows: with the black surface facing downward, hold the probe connector end against the notches on the probe holder, as shown in red (step 1 shown below).

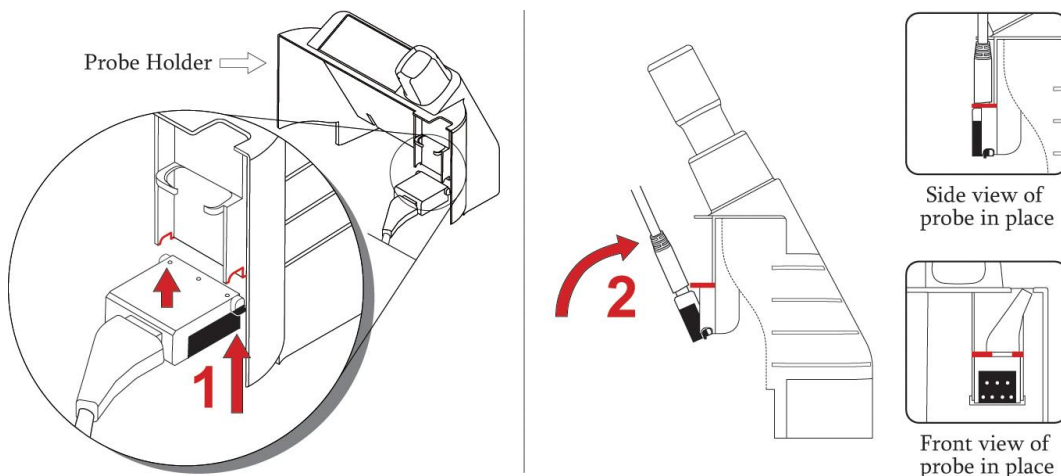

- Rotate the connector upwards until it snaps securely into place (step 2 shown above). The black surface faces outward and the cord extends upward.
- Slide part B onto part A as shown (this connects the temperature probe connector to the temperature unit connector), and insert the temperature probe into the well.

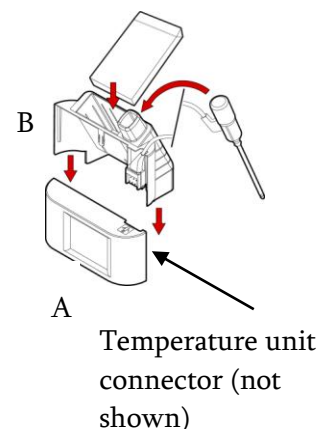

- Turn the device on using the power button on the right side of the BP module. At the end of the start-up sequence, the temperature module display will blank except for the appropriate temperature unit icon ($^{\circ}\text{F}$ or $^{\circ}\text{C}$). A short beep indicates that the *Sun Tech 247* is ready.

Note: If the temperature module does not appear to be working properly, cycle the power several times using the power button on the right side of the BP module. This will “synchronize” all the modules. The modules are synchronized when, after you turn the power on, all segments on all module displays light simultaneously for 3 to 5 seconds, followed by a short beep, and all displays go to their “ready” state (BP: battery icon and middle segments of the systolic value are lit; Temperature: appropriate temperature units icon is lit; Pulse Oximetry: the “%SpO₂” icon is lit).

Attaching the Pulse Oximetry Module

Should you need to attach or remove a pulse oximetry module, the following instructions give an overview of its attachment to the BP module. The pulse oximetry module attaches to the bottom of the BP module.

1. Using the power button on the right side of the BP module, ensure that the *SunTech 247* is off.
2. Remove the cover plate from the bottom of the main BP module.

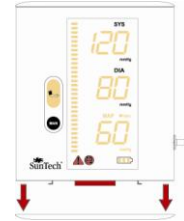

3. Slide the pulse oximetry module along the guides on the bottom of the main BP module from front to back until it snaps into place. All the segments of the pulse oximetry module display will light when the modules have been connected correctly.

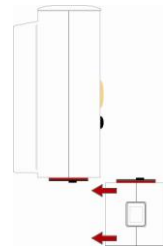

4. Turn the device on using the power button on the right side of the BP module. At the end of the start-up sequence, the pulse oximetry module display will blank except for the “%SpO2” symbol.
5. Turn the device off. Connect the sensor or extension cable to the connector on the module. Secure the cable to your device using the retention clip.



6. Turn the device on. All display segments light up for three to five seconds. A short beep indicates that the *SunTech 247* is ready.

Note: If the pulse oximetry module does not appear to be working properly, cycle the power several times using the power button on the right side of the BP module. This will “synchronize” all the modules. The modules are synchronized when, after you turn the power on, all segments on all module displays light simultaneously for 3 to 5 seconds, followed by a short beep, and all displays go to their “ready” state (BP: battery icon and middle segments of the systolic value are lit; Temperature: appropriate temperature units icon is lit; Pulse Oximetry: the “%SpO2” icon is lit).

Storage, Shutdown, Transport

Storage

The *SunTech 247* must be stored between -20°C (-4°F) and 55°C (131°F). Relative humidity must be less than 90%.

If you are storing the *SunTech 247* Battery for 30 days or longer, it is recommended that you disconnect the battery from the device.

Moving Your Device

To pack your device for repair or transport:

1. Detach the cuff, temperature probe, SpO₂ sensor, power supply, and other ancillary products from the device.
2. Disconnect the battery and remove it from the device.
3. Place the device in the original shipping carton, preferably with its original packing material.
4. Ensure that the device will be kept at between -20°C (-4°F) and 55°C (131°F) and in relative humidity less than 90% during transshipment.

TROUBLESHOOTING

The troubleshooting chart provides pointers on diagnosing issues associated with error or status codes.



Problem: The *SunTech 247* will not power on.

Solutions:

1. The *SunTech 247* must be plugged in to charge before first use.



Problem: My *SunTech 247* is not communicating with my EMR/EHR system or network

Solutions:

1. Be sure your SunTech 247 is equipped with the *Bluetooth®* option
2. Your 247 and wireless system must be configured to communicate. Refer to your EMR/EHR operator's manual or contact your IT administrator or EMR/EHR provider.
3. You may need to move your 247 closer to the wireless system. While the *Bluetooth®* capability on the 247 has been rated up to a maximum range of 10m, be sure to minimize walls, structures and other obstacles that may impede wireless connectivity.

Troubleshooting – Blood Pressure Module



Problem: Wrong size cuff, Misplaced cuff, or Blocked brachial artery

Solutions:

1. Check that the cuff is in the correct position.
2. Check that the cuff is properly tightened.
3. Check that there is no excessive clothing between the arm and the cuff.
4. Check that the cuff applied is of the correct size.
5. The patient may have been moving too much.
6. Take another BP reading.



Problem: Too much patient or environment motion or conditions causing tremors

Solutions:

1. Check that the cuff is in the correct position.
2. The patient may have been moving too much.
3. Take another BP reading.



Problem: Air leak, Loose cuff, or Blocked or pinched hose

Solutions:

1. Check that the hose has no sharp bends or is pinched.
2. Check that the patient is not lying on the cuff.
3. Check that the cuff is in the correct position.
4. Check that the hose is connected to the system and the cuff.
5. Check that the cuff is properly tightened.
6. Check that the correct size cuff is being applied.
7. Check that the cuff is not leaking air.
8. Check that the hose connections are not damaged or loose.
9. Take another BP reading.



Status Codes: 800, 900, 910, 970, 980, or 990

Problem: System error

Solutions:

1. Take another measurement.
2. If this is unsuccessful, power down, then power up the unit using the power button on the right side of the unit. If the error does not recur immediately, take another measurement.
3. If the error recurs, remove power from the unit (unplug any power supplies and remove the battery, if there is one), then reconnect the power. If the error does not recur immediately, take another measurement.
4. If the error recurs, contact *SunTech Medical Inc.* or an authorized service center.

Troubleshooting – Temperature Module



Status Code: 5

Problem: Temperature probe missing or outside of well

Solutions:

1. Remove and then place the probe in the well.
2. Ensure that the temperature well (the rear portion of the temperature module) is well seated on the display. Along the top of the module, the edge of the well should be flush with the display. Remove and carefully slide the well onto the display.

When properly fixed, the error should no longer be displayed. Take a new measurement.



Status Code: 10

Problem: Defective temperature probe

Solutions:

1. Remove and then place the probe in the well.
2. Ensure that the temperature well (the rear portion of the temperature module) is well seated on the display. Along the top of the module, the edge of the well should be flush with the display. Remove and carefully slide the well onto the display.

When properly fixed, the error should no longer be displayed. Turn the device off. After it has shut down, turn it on. The error should no longer be displayed. Take a new measurement.



Status Code: 15

Problem: Stuck button

Solution: Depress the Temperature units select button and/or the Temperature mode select button until the button becomes unstuck. When the button is unstuck, the error will no longer be displayed. If you cannot un-stick the button, contact *SunTech* or an authorized service center.



Status Code: 20

Problem: Hardware error

Solutions:

1. Take another measurement.
2. If this is unsuccessful, power down, then power up the unit using the power button on the right side of the unit. If the error does not recur immediately, take another measurement.
3. If the error recurs, remove power from the unit (unplug any power supplies and remove the battery, if there is one), then reconnect the power. If the error does not recur immediately, take another measurement.
4. If the error recurs, contact *SunTech* or an authorized service center.

Troubleshooting – Pulse Oximetry Module



Status Code: 01

Problem: Measurement time-out. The measurement time exceeded the 10-minute time limit.

Solution: Remove the sensor from the patient. Redisplay the last measurement prior to the timeout, or take a new measurement by placing the sensor on the patient.



Status Code: 02

Problem: Poor sensor position (signal is inadequate for a reliable measurement)

Solution: Adjust position of sensor on patient by placing sensor on opposite hand or ear or alternate site. Avoid fingers with nail polish or artificial nails.



Status Code: 05

Problem: The sensor has been disconnected from the device.

Solution: Reconnect the sensor. If you wish, you may leave the sensor disconnected as this code is only displayed once at the time the sensor is disconnected.



Status Code: 10

Problem: Defective sensor

Solution: Replace the sensor and take a new measurement.



Status Code: 20

Problem: Hardware error

Solutions:

1. Take another measurement.
2. If this is unsuccessful, power down, then power up the unit using the power button on the right side of the unit. If the error does not recur immediately, take another measurement.
3. If the error recurs, remove power from the unit (unplug any power supplies and remove the battery, if there is one), then reconnect the power. If the error does not recur immediately, take another measurement.
4. If the error recurs, contact *SunTech Medical Inc.* or an authorized service center.



Problem: Inadequate signal strength

Solution: If there is no measurement and the signal quality is low, try a different site or sensor. Avoid fingers with nail polish or artificial nails. If there is no improvement in signal quality, then discontinue use.

FAQs

Can I obtain replacement copies of the *SunTech 247* CD and manual?

Copies of the *SunTech 247* manual are available through the Customer Service area of our website. To download the manual, please visit <http://www.SunTechMed.com> and navigate to *Customer Service*. For a replacement CD, please email Customer Service at CustomerService@SunTechMed.com

How do I clean the *SunTech 247* device?

The *SunTech 247* requires only minimal cleaning. Wipe it down occasionally with a soft, damp cloth. Never immerse the device or apply cleaning fluid or solvents.

How do I install the rechargeable battery in the *SunTech 247*?

Remove the battery bay cover and position the rechargeable battery within, ensuring proper alignment of polarities. Replace the cover securely and connect the device to AC mains power via the power supply to turn the device on. Ensure the battery is fully charged before use. (See page 35 for detailed instructions.)

How often should I calibrate the BP Module for the *SunTech 247*?

You should check the calibration every two years. If there is a difference larger than 2 mmHg against the pressure reference, then contact an authorized service center on page 46.

How accurate is the *SunTech 247* blood pressure device?

The *SunTech 247*, designed for accuracy, has been manufactured to comply with AAMI SP10 protocol, and has been independently validated to both the British Hypertension Society (BHS) and European Society of Hypertension (ESH) standards for clinical accuracy.

What method of blood pressure measurement is used in the *SunTech 247*?

The *SunTech 247* takes automated BP measurements using the oscillometric method. It

supplements this with the ability to take measurements as you would if you were using a mechanical sphygmomanometer.

Can I upgrade my current version of *SunTech 247* at a later date?

To upgrade your *SunTech 247* device, please review the list of accessories on page 61 or on our website. Contact your local distributor for details.

Could I use the *SunTech 247* to measure blood pressure during a stress test?

Although your *SunTech 247* is a robust device that has been manufactured with motion tolerance, it is not intended for use during stress testing. Please use an alternate device like the SunTech® Tango®+ for treadmill or ergometer stress.

Should I wait between temperature measurements?

Yes. Accurate temperature measurement requires the probe to be at normal room temperature. After taking a measurement, wait for the probe to return to room temperature or wipe the probe with an alcohol wipe before taking a subsequent measurement.

Do I need to calibrate the temperature or pulse oximetry modules?

For calibration or service on the *SunTech 247* temperature and pulse oximeter modules, contact an authorized service center on page 46 - 46.

How accurately does the *SunTech 247* temperature module measure temperature?

The *SunTech 247* temperature module is accurate to +/- 0.2 °F (+/-0.1°C).

What is the accuracy of the *SunTech 247* pulse oximetry module?

The *SunTech 247* pulse oximetry module is +/- 2% in the 70 to 100% range for no motion and normal perfusion. For motion or low perfusion, the accuracy is +/- 3%.

When does the warranty period begin?

The warranty for your *SunTech 247* begins on the date of shipment of your device.

How do I make a warranty claim for the *SunTech 247*?

Contact an authorized service center on pages 46 - 46.

How do I get my *SunTech 247* to communicate with my EMR/EHR software system?

You must have the optional *Bluetooth*® capability to allow communication with any EMR/EHR system. Please contact your IT administrator or EMR/EHR system provider about configuring your *SunTech 247* for communication. Software development kits are available from SunTech Medical for EMR/EHR vendors to support communication with the *SunTech 247*.

Web Resources

www.SunTechMed.com

Service Centers

For customers in the Americas

SunTech Medical, Inc.
Service Department
507 Airport Boulevard, Suite 117
Morrisville, NC 27560
USA
Tel: +1. 919.654.2300
Fax: +1. 919.654.2301

For customers in Europe, the Middle East, and Africa

SunTech Medical, Ltd.
Oakfield Estate
Eynsham, Oxfordshire
England
Tel: +44 (0) 1865.884.234
Fax: +44 (0) 1865.884.235

For customers in Asia and the Pacific

SunTech Medical, Ltd.
Level 19, Two, International Finance Centre
8, Finance Street, Central
Hong Kong
Tel: +852.2251.1949
Fax: +852.2251.1950

SPECIAL SITUATIONS

Special Situations

Unique circumstances, such as the patient's age or physiological disturbances, require you to take special care while measuring blood pressure or vital signs. The more common examples of such circumstances are described here, to assist you in using your *SunTech 247* optimally under such conditions. You can find recommendations on dealing with each of these special situations in the American Heart Association's current scientific statement on recommendations for blood pressure measurement or the British Hypertension Society's current guidelines for management of hypertension.

Measuring Blood Pressure in Children

Typically, children exhibit greater variability in blood pressure than do adults. They are more likely to be crying, eating or restless in a clinical situation, further increasing the potential for variability.

Measuring Blood Pressure in Obese Patients

There appears to be a positive correlation between obesity and hypertension. Due to the increased arm circumference of obese patients, use of a "standard" cuff may lead to blood pressure being erroneously elevated – a condition known as "cuff hypertension."

Selecting an Appropriate Cuff for Obese Patients:

- For larger-than-normal upper arms, use a wider and longer cuff than you would otherwise use.
- Prominent biceps in a muscular upper arm require a large cuff.

Measuring Blood Pressure in the Presence of Arrhythmia

Irregular cardiac rhythms can result in a large variation in blood pressure from beat-to-beat. If you are using the *SunTech 247* on a patient with known arrhythmia, we recommend that you follow up with a *SphygMode* BP reading as a confirmatory measure.

In patients with severe regular bradycardia, take *SphygMode* rather than automatic readings.

Measuring Blood Pressure During Pregnancy

Hypertension is a common medical disorder of pregnancy, occurring in about ten percent of pregnancies. Detection of elevated blood pressure is essential to optimal prenatal care.

For clinically relevant hypertension in pregnancy, use the *SunTech 247* to take a *SphygMode* measurement.

Measuring Blood Pressure in the Elderly

In the elderly, the combination of hypertension and ageing can manifest as a decrease in arterial compliance. Variability in blood pressure can lead to a number of circadian blood pressure patterns that are best identified using ambulatory blood pressure measurement. The clinical consequence of this blood pressure variability is inaccurate readings.

Measuring Blood Pressure in the Emergency Room

Measuring blood pressure in the emergency room can be done through automated blood pressure measurements. For critically ill or injured patients, blood pressure should be measured through the invasive arterial pressure method.

Measuring Blood Pressure in the Presence of Orthostatic Hypotension

Orthostatic hypotension is defined as a decrease in systolic blood pressure of 20 mmHg or more or diastolic blood pressure of 10 mmHg or more measured after three minutes of standing up from a supine position. Food ingestion, time of day, age, and hydration can impact this form of hypotension, as can a history of Parkinsonism, diabetes, or multiple myeloma.

APPENDICES

Specifications

Patient population: Adult and pediatric patients (age 3 and above).

Method of measurement: Oscillometric

Initial inflation pressure: 160mmHg +/- 20mmHg

Blood pressure range (mmHg): 60< Systolic BP< 270, 30< Diastolic BP< 170

Blood pressure accuracy: Measurements determined with this device are equivalent to those obtained by a trained observer using the cuff/stethoscope auscultation method, within the limits prescribed by the American National Standard, *Manual, electronic or automated sphygmomanometers*.

Blood pressure determination time: 30-40 seconds typical for Adult cuff

Pulse rate range: 30-200 bpm +/- 2% or +/- 3 bpm, whichever is greater

Temperature range: 86°F (30.0°C) – 109.4°F (43.0°C)

Temperature accuracy: +/- 0.2°F (+/-0.1°C)

Functional oxygen saturation range: 40-100%

Functional oxygen saturation accuracy: 70-100% +/- 2 digits

(Note: because pulse oximeter equipment measurements are statistically distributed, only about two-thirds of pulse oximeter equipment measurements can be expected to fall within ± 2 digits of the value measured by a CO-oximeter.)

Operating conditions: 10°C (50°F) to 40°C (104°F) Less than 90% RH

Storage conditions: -20°C (-4°F) to 55°C (131°F) Less than 90% RH

Power: External power supply for non-battery version: Globtek model: GTM21089-1506-T3 (*SunTech* part number: 19-0013-00)

External power supply for Battery version, rechargeable by Globtek model: GTM21089-1509-T3 (*SunTech* part number 19-0014-00)

Calibration: Every two years

Safety systems: Independent hardware over-pressure circuit and redundant software overpressure algorithm to limit cuff pressure to less than 330 mmHg. Independent hardware timing circuit and redundant software timer algorithm to limit the duration of a blood pressure cycle to less than 180 seconds.

Dimensions: Length = 5.5 inches, Height = 11.5 inches, Width = 3.8 inches; Length =14.0 cm, Height = 29.2 cm, Width = 9.7 cm

Standards: UL60601-1, CAN/CSA C22.2 601-1

IEC 60601-1, IEC 60601-1-2 (EMC), IEC 60601-1-4, ISO 9919, AAMI SP10:2002, ASTM E 1112, EN 12470-3

Meets EN-1060-1, Specification for non-invasive sphygmomanometers – Part 1: General requirements and EN 1060-3, Non-invasive Sphygmomanometers – Part 3. Supplementary Requirements for Electro-Mechanical BP Measuring Systems”

Classification: Protection against electric shock: Class II (for non-battery version), Internally Powered Equipment (for battery version); Applied parts: Type BF; Mode of operation: Continuous

IP index: IPX0

Compliance



SunTech Medical, Ltd.
Oakfield Industrial Estate
Eynsham, Oxfordshire OX29 4TS
UK
Tel: +44. 1865.884.234
Fax: +44. 1865.884.235

Safety Requirements

Clinical grade BP measurement accuracy defined by fully meeting the requirements of:

- AAMI SP-10 2002
- EN 1060-4

EMC Statement



This equipment has been tested and found to comply with the limits for medical devices to IEC60601-1-2: 2001. These limits are designed to provide reasonable protection against harmful interference in a typical medical installation. This equipment generates, uses, and can radiate radio frequency energy and, if not installed and used in accordance with the instructions, may cause harmful interference to other devices in the vicinity. This equipment should not be used adjacent to or stacked with other equipment. If this is necessary, the equipment should be observed to verify normal operation in the configuration in which it will be used. However, even if used properly, there is no guarantee that interference will not occur in a particular installation. If this equipment does cause harmful interference to other devices, which can be determined by turning the equipment off and on, the user is encouraged to try to correct the interference by one or more of the following measures:









- Reorient or relocate the receiving device
- Increase the separation between the equipment
- Connect the equipment into an outlet on a circuit different from that to which the other device(s) are connected
- Consult the manufacturer or field service technician for help

Use only *SunTech*-approved cables and accessories with this device. Use of unauthorized cables or accessories may result in increased emissions or decreased immunity. Portable and mobile RF communications equipment can affect Medical Electrical Equipment.

Symbols

The following symbols are associated with the *SunTech 247*:

SYMBOL	DESCRIPTION
	Manufactured by
	ETL certified
	Power supply contains materials which are hazardous. Must be disposed of properly.

SYMBOL	DESCRIPTION
	No SpO ₂ alarm
	Attention, consult accompanying documents.
	Class II isolation equipment
	CE approval
	Recognized component certified by UL to both Canada and US requirements
	TUV Canada and US approval
	TUV International approval
	Earth ground
	Output connection configuration – positive voltage; negative shield

Guidance and manufacturer's declaration – electromagnetic emissions

The *SunTech 247* is intended for use in the electromagnetic environment specified below. The customer or the user of the *SunTech 247* should assure that it is used in such an environment.

Emissions test	Compliance	Electromagnetic environment – guidance
RF emissions CISPR 11	Group 1	The <i>SunTech 247</i> uses RF energy only for its internal function. Therefore, its RF emissions are very low and are not likely to cause any interference in nearby electronic equipment.
RF emissions CISPR 11	Class B	The <i>SunTech 247</i> is suitable for use in all establishments, including domestic establishments and those directly connected to the public low-voltage power supply network that supplies buildings used for domestic purposes.
Harmonic emissions IEC 61000-3-2	Class A	
Voltage fluctuations/ flicker emissions IEC 61000-3-3	Complies	

Guidance and manufacturer's declaration – electromagnetic immunity			
The <i>SunTech 247</i> is intended for use in the electromagnetic environment specified below. The customer or the user of the <i>SunTech 247</i> should assure that it is used in such an environment.			
Immunity test	IEC 60601 test level	Compliance level	Electromagnetic environment – guidance
Electrostatic discharge (ESD) IEC 61000-4-2	±6 kV contact ±8 kV air	±6 kV contact ±8 kV air	Floors should be wood, concrete or ceramic tile. If floors are covered with synthetic material, the relative humidity should be at least 30%.
Electrical fast transient/burst IEC 61000-4-4	±2 kV for power supply ±1 kV for input/output lines	±2 kV for power supply ±1 kV for input/output lines	Mains power quality should be that of a typical commercial or hospital environment.
Surge IEC 61000-4-5	±1 kV differential mode ±2 kV common mode	±1 kV differential mode ±2 kV common mode	Mains power quality should be that of a typical commercial or hospital environment.
Voltage dips, short interruptions and voltage variations on power supply input lines IEC 61000-4-11	<5% U_T (>95% dip in U_T) for 0, 5 cycle 40% U_T (60% dip in U_T) for 5 cycles 70% U_T (30% dip in U_T) for 25 cycles <5% U_T (>95% dip in U_T) for 5 sec	<5% U_T (>95% dip in U_T) for 0, 5 cycle 40% U_T (60% dip in U_T) for 5 cycles 70% U_T (30% dip in U_T) for 25 cycles <5% U_T (>95% dip in U_T) for 5 sec	Mains power quality should be that of a typical commercial or hospital environment. If the user of the <i>SunTech 247</i> requires continued operation during power mains interruptions, it is recommended that the <i>SunTech 247</i> be powered from an uninterruptible power supply or a battery.
Power frequency (50/60 Hz) magnetic field IEC 61000-4-8	3 A/m	3 A/m	Power frequency magnetic fields should be at levels characteristic of a typical commercial or hospital environment.
NOTE U_T is the AC mains voltage prior to application of the test level			

In the event of a power loss to the device, all user settings are saved. The device will power-up with the same settings as prior to the power loss. The device does not store patient data.

Guidance and manufacturer's declaration – electromagnetic immunity

The *SunTech 247* device is intended for use in the electromagnetic environment specified below. The customer or the user of the *SunTech 247* device should assure that it is used in such an environment.

Immunity test	IEC 60601 test level	Compliance level	Electromagnetic environment - guidance
Conducted RF IEC 61000-4-6	3 Vrms 150 kHz to 80 MHz	3V	<p>Portable and mobile RF communications equipment should be used no closer to any part of the <i>SunTech 247</i>, including cables, than the recommended separation distance calculated from the equation applicable to the frequency of the transmitter.</p> <p>Recommended separation distance $d = [3.5/V_1] \sqrt{P}$</p>
Radiated RF IEC 61000-4-3	3V/m 80 MHz to 2.5 GHz	3 V/m	<p>$d = [3.5/E_1] \sqrt{P}$ 80MHz to 800MHz $d = [7/E_1] \sqrt{P}$ 800MHz to 2.5GHz</p> <p>where P is the maximum output power rating of the transmitter in watts (W) according to the transmitter manufacturer and d is the recommended separation distance in meters (m). Field strengths from fixed RF transmitters, as determined by an electromagnetic site survey^a, should be less than the compliance level in each frequency range^b.</p> <p>Interference may occur in the vicinity of equipment marked with the following symbol:</p> 

NOTE 1—At 80 MHz and 800 MHz, the higher frequency range applies.

NOTE 2—These guidelines may not apply in all situations. Electromagnetic propagation is affected by absorption and reflection from structures, objects, and people.

^a Field strengths from fixed transmitters, such as base stations for radio (cellular/cordless) telephones and land mobile radios, amateur radio, AM and FM radio broadcast, and TV broadcast cannot be predicted theoretically with accuracy. To assess the electromagnetic environment due to fixed RF transmitters, an electromagnetic site survey should be considered. If the measured field strength in the location in which the *SunTech 247* device is used exceeds the applicable RF compliance level above, the *SunTech 247* device should be observed to verify normal operation. If abnormal performance is observed, additional measures may be necessary, such as re-orienting or relocating the *SunTech 247* device.

^b Over the frequency range 150 kHz to 80 MHz, field strengths should be less than 3 V/m.

Recommended separation distances between portable and mobile RF communications equipment and the *SunTech 247* device

The *SunTech 247* device is intended for use in an electromagnetic environment in which radiated RF disturbances are controlled. The customer or the user of the *SunTech 247* device can help prevent electromagnetic interference by maintaining a minimum distance between portable and mobile RF communications equipment (transmitters) and the *SunTech 247* device as recommended below, according to the maximum output power of the communications equipment.

Rated maximum output power of transmitter W	Separation distance according to frequency of transmitter m		
	150 kHz to 80 MHz $d = [3.5/V_1] \sqrt{P}$	80 MHz to 800 MHz $d = [3.5/V_1] \sqrt{P}$	800MHz to 2.5GHz $d = [7/E_1] \sqrt{P}$
0.01	0.12	0.12	0.23
0.10	0.38	0.38	0.73
1	1.2	1.2	2.3
10	3.8	3.8	7.3
100	12	12	23

For transmitters rated at a maximum output power not listed above, the recommended separation distance d in meters (m) can be estimated using the equation applicable to the frequency of the transmitter, where P is the maximum output power rating of the transmitter in watts (W) according to the transmitter manufacturer.

NOTE 1—At 80 MHz and 800 MHz, the separation distance for the higher frequency range applies.

NOTE 2—These guidelines may not apply in all situations. Electromagnetic propagation is affected by absorption and reflection from structures, objects, and people.

For units that are *Bluetooth*® enabled, the following EU and FCC regulatory information applies:

EU Regulatory Information

The transmitter module manufactured by Mitsumi and incorporated into the 247 BP module marked by **CE 0413** ⓘ has been approved in accordance with the R&TTE directive.

FCC Regulatory Information

FCC RF Interference Statement:

This equipment has been tested and found to comply with the limits pursuant to Part 15 of the FCC rules.

These limits are designed to provide reasonable protection against harmful interference in a residential installation.

This equipment generates, uses and radiates radio frequency energy and, if not installed and used in accordance with the instructions, may cause harmful interference to radio communication. However, there is no guarantee that interference will not occur in a particular installation. If this equipment does cause harmful interference to radio or television reception, which can be determined by turning the equipment off and on, the user is encouraged to try to correct the interference by one of more of the following measures:

- Reorient or relocate the receiving antenna.
- Increase the separation between the equipment and receiver.
- Connect the equipment into an outlet on a circuit different from that to which the receiver is connected.
- Consult the dealer or an experienced radio/TV technician for help.

Operation is subject to the following two conditions: (1) this device may not cause harmful interference, and (2) this device must accept any interference received, including interference that may cause undesired operation. This device contains FCC-ID P00WML-C40.

FCC RF Exposure Statement:

This device complies with FCC radiation exposure limits set forth for an uncontrolled environment. End users must follow the specific operation instructions for satisfying RF exposure compliance. This transmitter must not be co-located or operating in conjunction with any other antenna or transmitter.

This mobile modular transmitter must have a separation distance of at least 20 cm between the antenna and the body of the user or nearby persons. With a separation distance of 20 cm or more, the MPE limits are well above the potential this module is capable of producing.

Note: Unauthorized modifications will void the authority to use this equipment.

Limited Warranty

SunTech 247 Device

SunTech Medical, Inc. provides the original purchaser the following limited warranty from date of invoice.

All serialized modules	24 months
APC Cuff(s)	24 months
Roll stand	24 months
Accessories, i.e. patient cables, disposables, power supplies	90 days

SunTech Medical, Inc. warrants each instrument to be free from defects in material and workmanship. Liability under this warranty covers servicing of the instrument when returned from the customer's facility within the United States prepaid to the factory. *SunTech Medical, Inc.* will repair any component(s) or part(s) that it finds to be defective during the period of this limited warranty. Should a defect become apparent, the original purchaser should first notify *SunTech Medical, Inc.* of the suspected defect. The instrument should be carefully packaged and shipped prepaid to:

For customers in the Americas:

SunTech Medical, Inc.
Service Department
507 Airport Boulevard, Suite 117
Morrisville, NC 27560
USA
Tel: +1. 919.654.2300
Fax: +1. 919.654.2301

OR

For customers in Europe, Middle East, Africa, Asia, and the Pacific:

SunTech Medical, Ltd.
Service Department
Oakfield Industrial Estate
Eynsham, Oxfordshire OX29 4TS
UK
Tel: +44. 1865.884.234
Fax: +44. 1865.884.235

The instrument will be repaired in the shortest possible time and returned prepaid by the same shipping method as received by the factory. This limited warranty is void if the instrument has been damaged by accident, misuse, negligence, act of God or serviced by any person not authorized by *SunTech Medical, Inc.*

This limited warranty contains the entire obligation of *SunTech Medical, Inc.* and no other warranties expressed, implied or statutory are given. No representative or employee of *SunTech Medical, Inc.* is authorized to assume any further liability or grant any further warranties except as herein.

Purchasing Parts and Accessories

We recommend that you purchase parts and accessories for your *SunTech 247* from your authorized *SunTech 247* distributor. A consolidated list of parts and accessories appears below.

All Purpose - General Clinical Use Cuffs		
Item #	Item Name	Item Description
98-0223-00	All Purpose Cuff package, Adult	Includes Small Adult, Adult, Adult Long, Large Adult cuffs with quick-connect connectors
98-0224-00	All Purpose Cuff package, Pediatric	Includes Child and Small Adult cuffs with quick-connect connectors
98-0080-02	All Purpose Cuff, Child	Blood Pressure Cuff with quick-connect connector, Range: 12-19cm Color: Green
98-0080-03	All Purpose Cuff, Child Long	Blood Pressure Cuff with quick-connect connector, Range: 12-19cm Color: Green
98-0080-04	All Purpose Cuff, Small Adult	Blood Pressure Cuff with quick-connect connector, Range: 17-25cm Color: Royal Blue
98-0080-05	All Purpose Cuff, Small Adult Long	Blood Pressure Cuff with quick-connect connector, Range: 17-25cm Color: Royal Blue
98-0080-06	All Purpose Cuff, Adult	Blood Pressure Cuff with quick-connect connector, Range: 23-33cm Color: Navy Blue
98-0080-07	All Purpose Cuff, Adult Long	Blood Pressure Cuff with quick-connect connector, Range: 23-33cm Color: Navy Blue

98-0080-08	All Purpose Cuff, Large Adult	Blood Pressure Cuff with quick-connect connector, Range: 31-40cm Color: Burgundy
98-0080-09	All Purpose Cuff, Large Adult Long	Blood Pressure Cuff with quick-connect connector, Range: 31-40cm Color: Burgundy
98-0080-10	All Purpose Cuff, Thigh	Blood Pressure Cuff with quick-connect connector, Range: 38-50cm Color: Brown

Pulse Oximetry Accessories		
Item #	Item Name	Item Description
52-0005-00	Adult digit reusable oximetry sensor (Nellcor®-compatible)	Reusable finger sensor with 10ft (3.0m) cable and DB-9M connector for persons >88 lbs (>40kg)
52-0005-01	Y multi-site reusable oximetry sensor (Nellcor®-compatible)	Reusable universal Y sensor including ear clip with 36" (.91 m) cable and DB-9M connector for all patients >2.2lbs (>1 kg)
52-0005-04	6-foot SpO2 Sensor Extension Cable (Nellcor®-compatible)	Reusable cables with DB-9 M & F connectors
52-0005-05	10-foot SpO2 Sensor Extension Cable (Nellcor®-compatible)	Reusable cables with DB-9 M & F connectors
52-0007-00	Adult digit reusable oximetry sensor (<i>vSat</i>)	Reusable finger sensor with 10ft (3.0m) cable and DB-9M connector for persons >88 lbs (>40kg)

Thermometry Accessories (Kendall FASTEMP®)		
Item #	Item Name	Item Description
98-0155-00	Red Rectal Temperature Kit	Includes rectal probe, well, and box of probe covers
52-0004-00	Blue Oral/Axillary Probe	Oral/axillary probe with 9 ft (2.7 m) extended cord
98-0146-00	Blue Oral/Axillary Well	Rear piece of the temperature module that holds the oral/axillary probe and box of probe covers
52-0004-01	Red Rectal Probe	Rectal probe with 9 ft (2.7 m) extended cord
98-0147-00	Red Rectal Well	Rear piece of the temperature module that holds the rectal probe and box of probe covers
98-0130-01	Disposable Probe Covers, 5000	10 trays (25 boxes/tray, 20/probe covers/box)
98-0130-01	Disposable Probe Covers, 5000	250 boxes (20 probe covers/box)
98-0131-01	Disposable Probe Covers, 500	25 boxes (20 probe covers/box)
52-0004-02	Calibration plug	Kendall part number 202099

Miscellaneous Accessories		
Item #	Item Name	Item Description
98-0154-00	Mobile stand kit	Includes base, pole, power supply holder, storage basket, handle, and assembly instructions

98-0149-00	Tabletop stand kit	Includes power supply holder
98-0148-00	Wall mount kit	Includes wall mountable basket
98-0150-00	Basket	Wall mountable
19-0013-00	Power supply for the <i>SunTech 247</i>	Input: 100-240 V, 50-60 Hz; Output: +6 V; medical grade
19-0014-00	Power supply for the <i>SunTech 247</i> Battery	Input: 100-240 V, 50-60 Hz; Output: +9 V; medical grade
91-0003-05	EU power cord	Power or mains lead with Type E and F hybrid, CEE 7/7, two pin plug, 8.2 ft (2.5 m) length
91-0003-06	UK power cord	Power or mains lead with Type G, BS1363, three pin plug, 8.2 ft (2.5 m) length
91-0003-00	US power cord	Power or mains lead with Type B, NEMA 5-15. three pin plug, 8.2 ft (2.5m) length
91-0097-00	BP hose	BP hose with mate for threaded screw type connector, 8 ft (2.4 m) length
17-0014-00	Rechargeable battery	6V, sealed lead acid battery
80-0041-00	Service Manual	



www.SunTechMed.com

SunTech Medical, Inc.
507 Airport Boulevard, Suite 117
Morrisville, NC 27560
USA
Tel: +1. 919.654.2300
+1. 800.421.8626
Fax: +1. 919.654.2301

SunTech Medical, Ltd.
Level 19, Two, International Finance Centre
8, Finance Street, Central
Hong Kong
Tel: +852.2251.1949
Fax: +852.2251.1950

SunTech Medical, Ltd.
Service Department
Oakfield Industrial Estate
Eynsham, Oxfordshire OX29 4TS
UK
Tel: +44. 1865.884.234
Fax: +44. 1865.884.235



Part #80-0040-00 Rev. G

Nellcor® is a registered trademark of Nellcor Puritan Bennett LLC

FILAC™ and FASTEMP™ are registered trademarks of Tyco Healthcare Group LP

The *Bluetooth*® word mark and logos are registered trademarks owned by Bluetooth SIG, Inc. and any use of such marks by SunTech Medical, Inc. is under license.